

# CONSTRUCTION AND MAINTENANCE OF MASONRY HOUSES

For masons  
and **craftsmen**

MARCIAL **BLONDET**  
editor



PONTIFICIA  
UNIVERSIDAD  
CATÓLICA  
DEL PERÚ



Earthquake Engineering  
Research Institute



# **CONSTRUCTION AND MAINTENANCE OF MASONRY HOUSES**

For masons and craftsmen

**MARCIAL BLONDET**

Editor

## **AUTHORS**

### **PUCP**

**Director:** *Dr. Eng. Marcial Blondet*

**Construction:** *Eng. Iván Bragagnini*

**Structures:** *Mag. Eng. Gianfranco Ottazzi*

**Architecture:** *Arch. Mariana Bidart*

**Research Assistant:** *Eng. Nicola Tarque*

**Research Assistant:** *Eng. Miguel Mosqueira*

**Design and edition:** *Arch. Mariana Bidart*

**Art:** *Mr. Víctor Sanjinez*

**Translation:** *Eng. Gladys Villa Garcia*

### **SENCICO**

**Technical Consultant:** *Ing. Carmen Kuroiwa*

**Technical Consultant:** *Ing. Gabriela Esparza*

## **Acknowledgements**

*The authors thank the following persons and institutions for their help in the elaboration of this booklet:*

*- To PUCP students Miguel Baca, Joen Bazán, Michael Dueñas, Roberto Flores, Sandra Godenzi, Johan Laucata, José Puente, Paúl Rojo and Carla Valdivieso. They visited various cities of the Peruvian coast to collect information about informal constructions.*

*- To engineers Julio Arango, Antonio Blanco, Carlos Casabonne, Héctor Gallegos, Gerardo Jáuregui, Alejandro Muñoz, Pablo Orihuela, Julio Rivera and Ángel San Bartolomé. All of them reviewed a preliminary version of this booklet and contributed with valuable suggestions.*

*-To Professor Richard Klingner for his contributions to the second version of the booklet and for his review of the translation from Spanish to English.*

*- To the Dirección Académica de Investigación (Academic Direction of Research) of the PUCP and to SENCICO for the economic support given to carry out on-site activities and to develop this booklet.*

*- To the Earthquake Engineering Research Institute (EERI) of California, U.S.A. for the funding of the second printing of this booklet.*

## **In appreciation**

*The authors wish to state that they have been inspired and have taken material from the following excellent booklets about masonry construction:*

*- Gallegos, Ríos, Cassabonne, Ucelli, Icochea and Arango. 1995. **Construyendo con ladrillo** (Building with Brick), CAPECO, Lima, Perú.*

*- Asociación Colombiana de Ingeniería Sísmica (Colombian Association of Earthquake Engineering). 2001. **Manual de construcción, evaluación y rehabilitación sismo resistente de viviendas de mampostería** (Handbook for construction, evaluation and seismic rehabilitation of masonry houses). AIS, Colombia.*

Second edition: January 2005  
Version 3.0

CONSTRUCTION AND MAINTENANCE OF MASONRY HOUSES  
For masons and craftsmen

© Marcial Blondet

© Pontificia Universidad Católica del Perú  
University Avenue, San Miguel, Lima 32, Peru  
Phone 626-2000  
E mail: [inveciv@pucp.edu.pe](mailto:inveciv@pucp.edu.pe)

© SENCICO  
Canada Avenue 1568, San Borja, Lima 41, Peru  
Phone 475-3821  
E mail: [din1@sencico.com.pe](mailto:din1@sencico.com.pe)

Total or partial reproduction of this publication by any means is permitted as long as the source is credited.

Printed in Peru

*For Virgilio Ghio C.*

# TABLE OF CONTENTS

<b>Chapter 1: Natural Hazards</b> . . . . .	6
1 Natural hazards in Peru	
2 Earthquakes	
<b>Chapter 2: The earthquake resistant house</b> . . . . .	8
1 Adequate locations	
2 Inadequate locations	
3 The earthquake resistant house	
4 Configuration of an earthquake-resistant house	
5 The unsafe house	
6 The safe house	
7 Components of the building utilities	
<b>Chapter 3: Construction of a safe house</b> . . . . .	18
1 Drawings and other administrative procedures	
2 Cleaning and leveling the land	
3 Layout	
4 Construction of the foundation	
5 Column rebar assembly	
6 Walls	
7 Pouring concrete in confining columns	
8 Confining beams	
9 Lightweight slab	
10 Stairs	
<b>Chapter 4: Maintaining your house</b> . . . . .	48
1 Cracked walls	
2 Corrosion of reinforcing steel	
3 Efflorescence	
4 Wall moisture	
<b>Chapter 5: Plans for your house</b> . . . . .	53
1 Why are drawings useful?	
2 The design of your house	
3 Sample house plans	
<b>References</b> . . . . .	82
<b>Appendix</b> . . . . .	83
1 Quantity of walls in an earthquake-resistant house	
2 Concrete types	
3 Schedule of material quantities	

---

# INTRODUCTION



Peru is located in a seismic area. From time to time earthquakes occur which affect inadequately constructed houses, causing major damage and in many cases partial or total collapse.

In this booklet we will show you how to build earthquake-resistant houses. Remember the importance of consulting a Civil Engineer before preparing your drawings and constructing your house.



### 1 • Natural hazards in Peru

Many regions of our country are vulnerable to natural hazards such as avalanches, floods or earthquakes. It is important to understand the effects of these natural phenomena to decide where and how to build safe houses.

#### Avalanches

Major movement of earth, mud and rocks that occurs when significant rain has fallen over the mountains.



#### El Niño phenomenon

The El Niño phenomenon is responsible for warming of sea water, which results in substantial rain in the coastal and highland areas of our country. When this phenomenon occurs, avalanches, floods and landslides are more frequent.

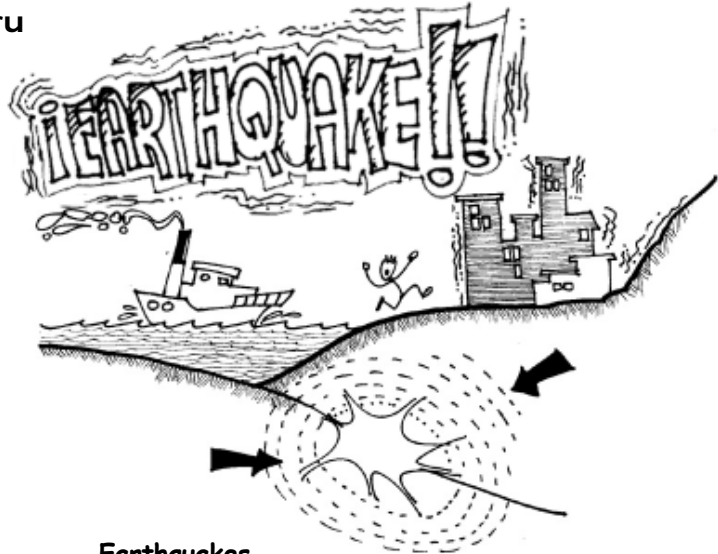
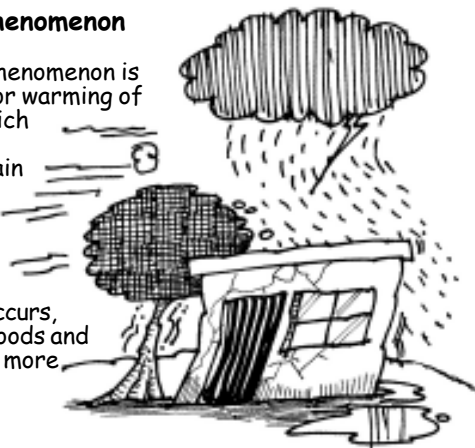

#### Earthquakes

Strong movements that occur inside the earth's crust and that produce strong vibrational movement in the soil which supports houses.



#### Floods

Are produced when a river overflows its banks.



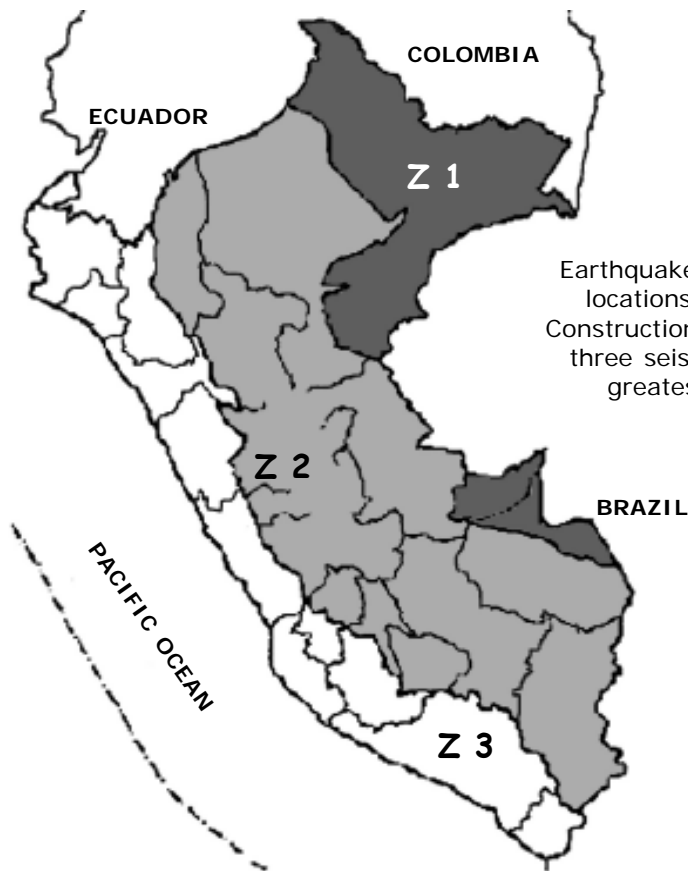

## 2 • Earthquakes

Earthquake risk is not the same in all locations. That is why the National Construction Code has divided Peru in three seismic regions. The region of greatest seismic risk is the coast.

Seismic regions according to the National Construction Code:

	Z1	Low seismicity
	Z2	Medium seismicity
	Z3	High seismicity

### What type of damage can earthquakes produce?

Earthquakes can produce significant damage to inadequately designed and constructed houses. For example, parapets can fall, window glass can break or walls can crack. Houses with severe structural problems can collapse, causing major material loss, serious injury to its occupants and even the regrettable loss of lives.

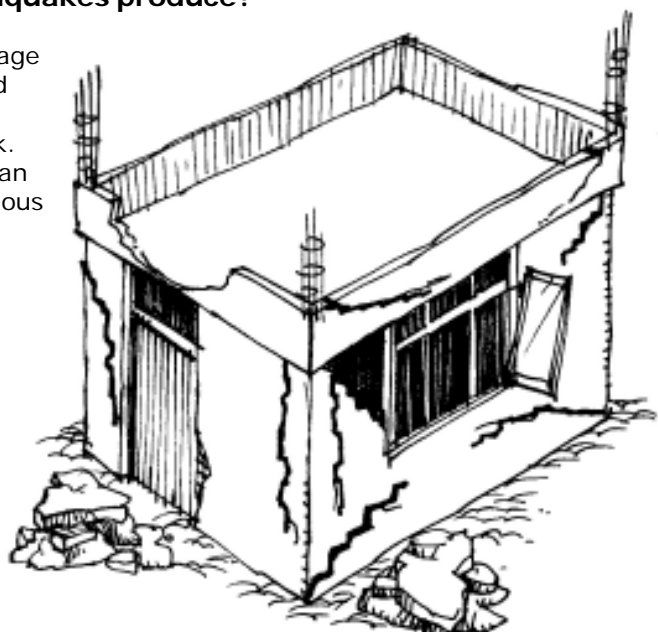

# 2 THE EARTHQUAKE-RESISTANT HOUSE

CHAPTER

## 1 • Adequate locations

Safe places to build houses are those located far from areas where natural hazards may occur. The best location is flat terrain, with stable and strong ground consisting of rock or gravel.

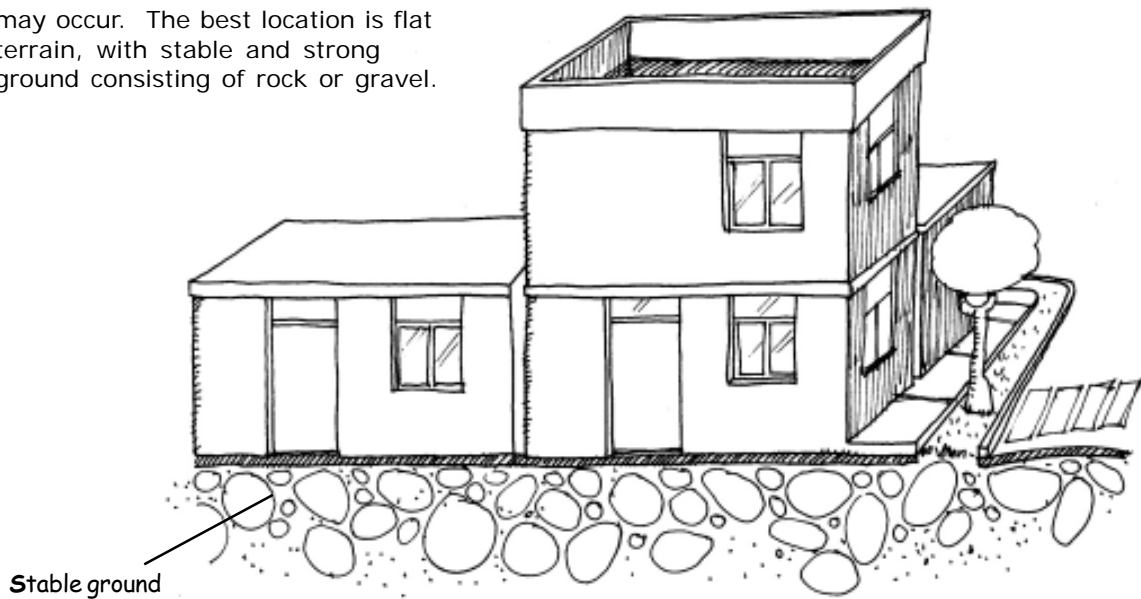

## 2 • Inadequate locations

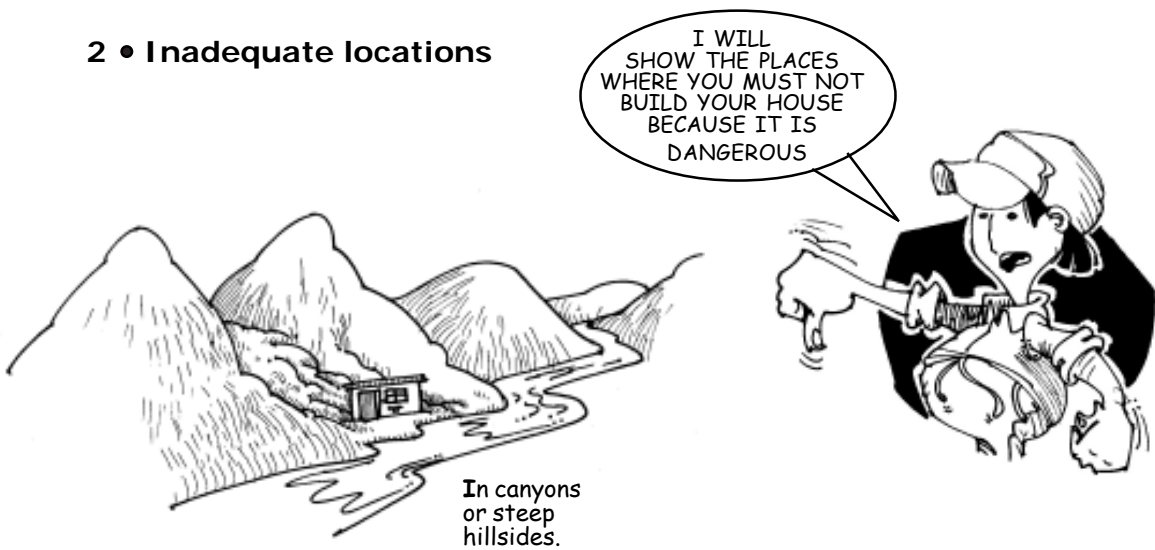

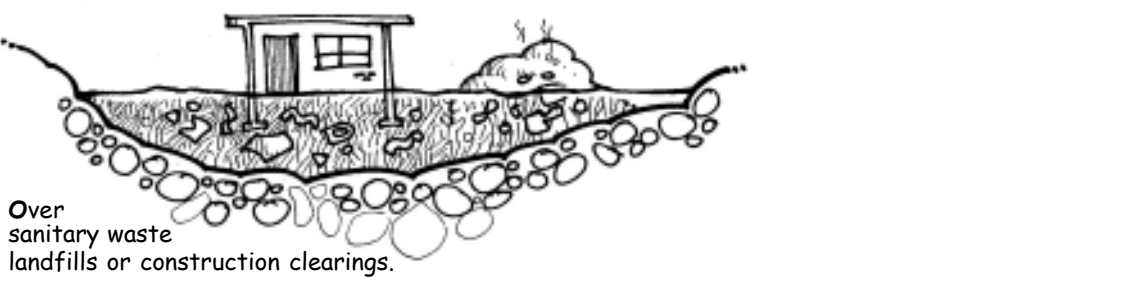
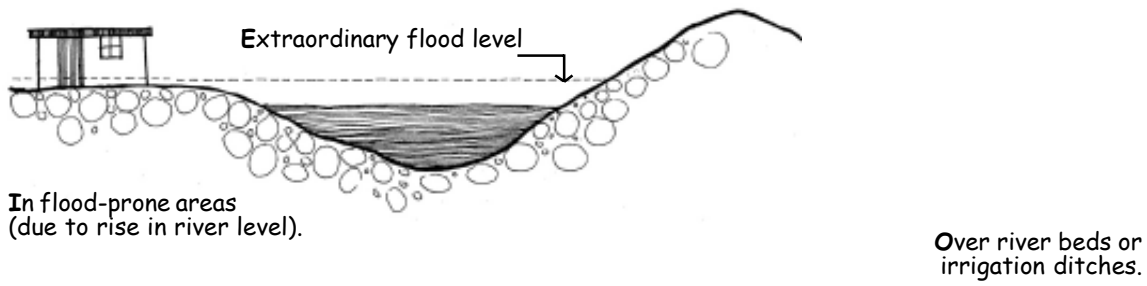
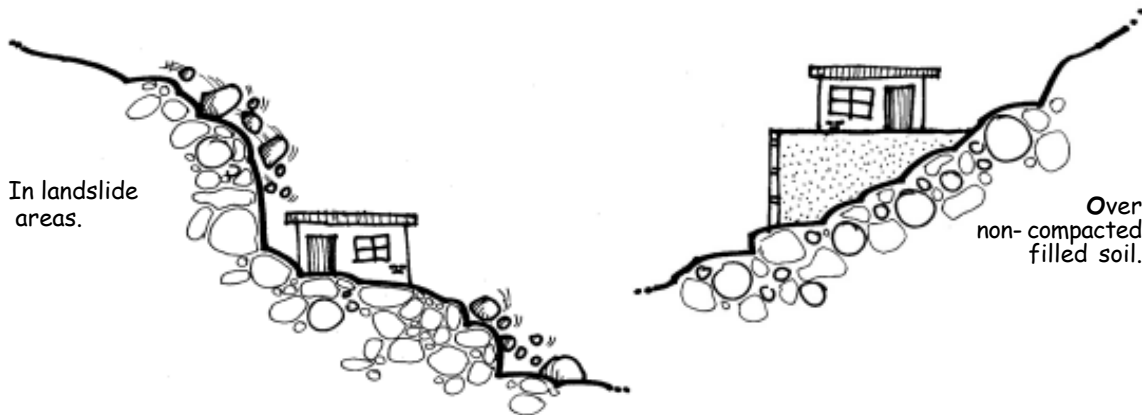

### 3 • The earthquake-resistant house

A confined brick masonry earthquake-resistant house is designed and constructed so that its walls are able to resist earthquakes. Its plan view must be simple and symmetrical. Its bearing walls must be well constructed and must always be confined by reinforced concrete columns and beams.

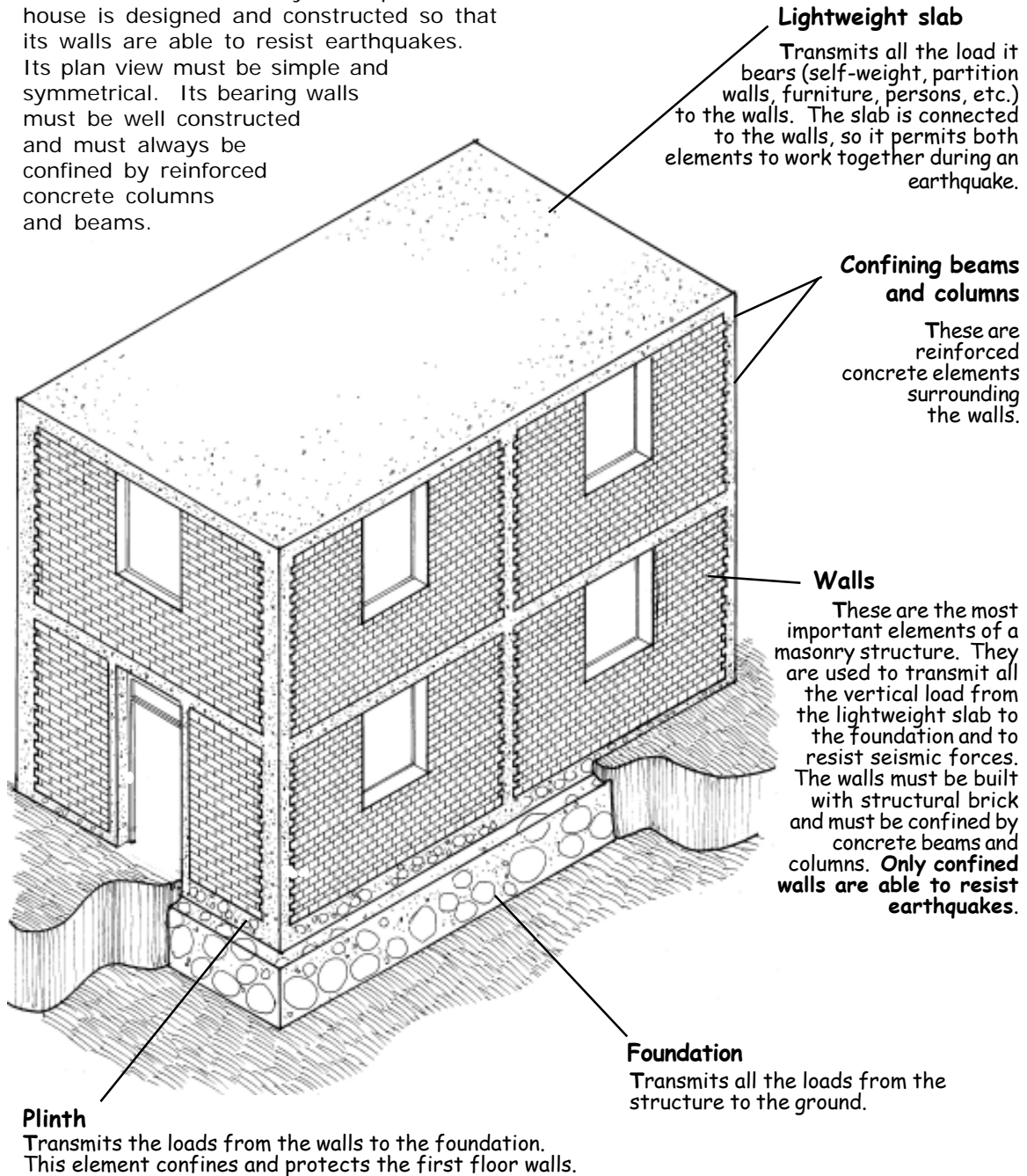

#### **Recommendations**

*Walls confined by beams and columns resist earthquakes. If you want your house to be earthquake-resistant, we recommend that it should have the greatest possible quantity of confined walls in both directions.*

*Partition walls, made with lightweight hollow clay tile, are used only to separate rooms inside the house.*



#### 4 • Layout of an earthquake-resistant house

If you want your house to resist earthquakes successfully, your design must have a good shape and an adequate distribution of walls.



**NO**

**Irregular**

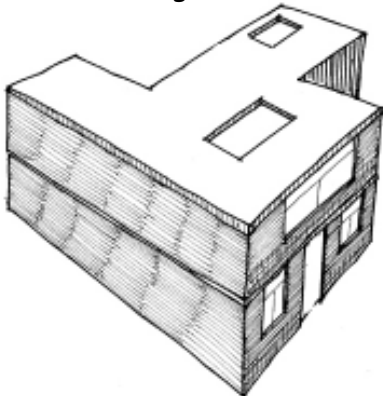

**YES**

**Symmetrical**

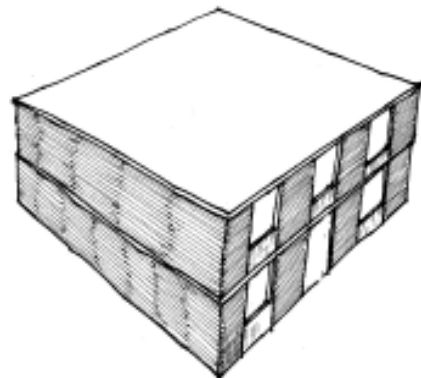

The shape of your house has to be as symmetrical as possible, both in plan view as well as elevation. Lightweight slabs must not have too many openings.

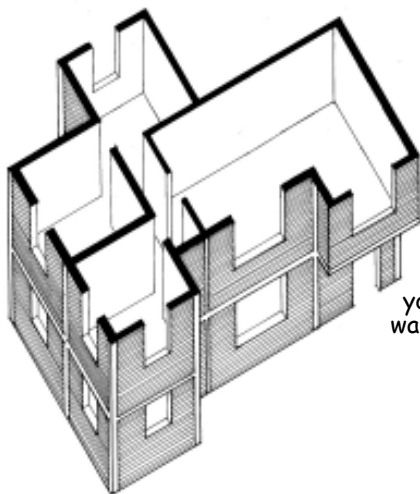

**Inadequate plan layout**

Look for symmetry in your house when you build the walls. You must try to have the same number of walls in both directions.



**Adequate shape**

**NO**

**YES**

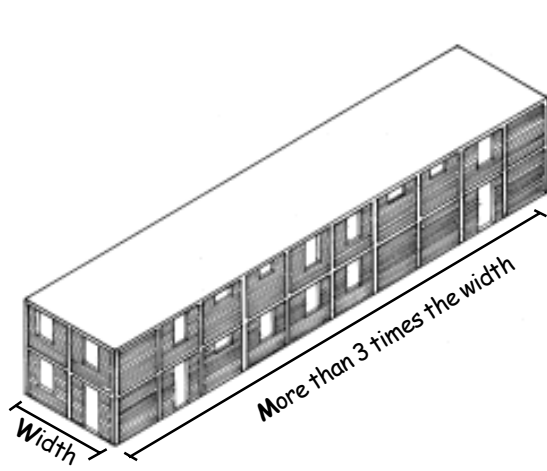

**Poorly proportioned plan**

The plan length of your house should not be greater than 3 times its plan width.

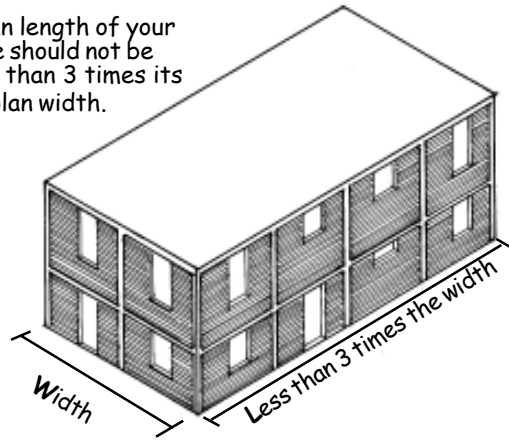

**Well proportioned plan**

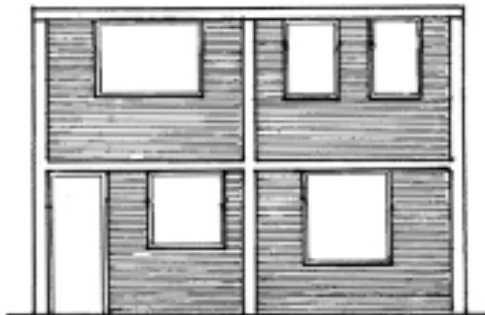

**Poor location of window and door openings**

Build window and door openings up to the level of the collar beam and locate them in the same position on every floor.



**Good location of window and door openings**

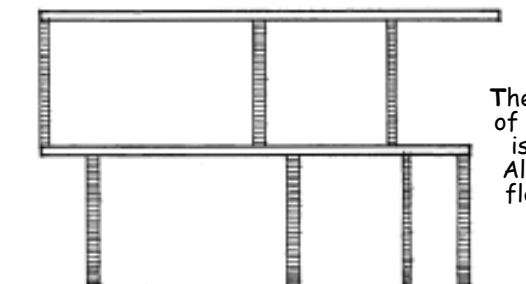

**Improperly located walls that do not rest over other walls**

The adequate location of second floor walls is very important. Always build second floor walls exactly over first floor walls.

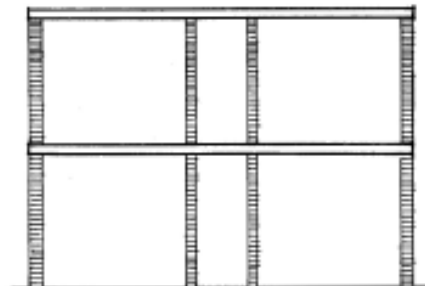

**Properly located walls**

**NO**

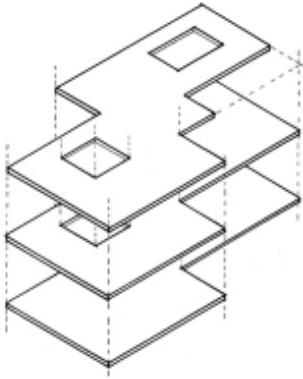

Slabs of different shape on every floor

**YES**

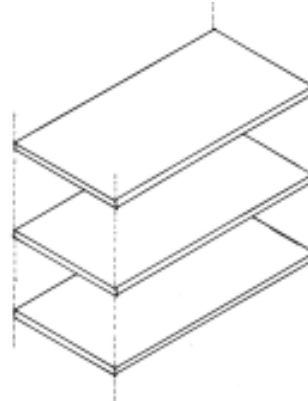

The same shape of slab on every floor

It is important for slabs to be well proportioned and to have the same shape on every floor.

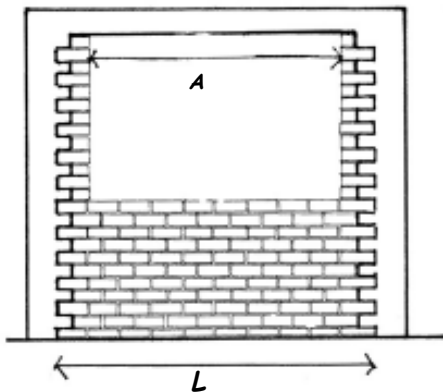

Inadequate opening proportions

Openings weaken the walls. Do not include openings longer than half the length of the wall. (The distance A must be less than half the distance L).

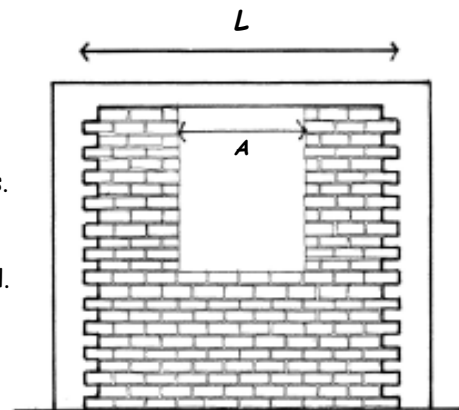

Adequate opening proportions

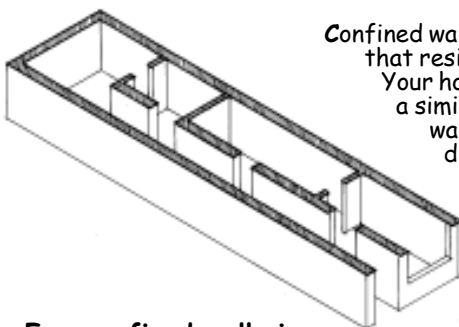

Few confined walls in the short direction of the house

Confined walls are the elements that resist earthquakes. Your house must have a similar number of walls in both directions.

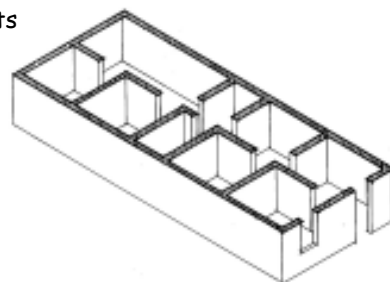

Many confined walls in both directions



### 5 • The unsafe house

#### UNQUALIFIED MANUAL LABOR



THIS DRAWING SHOWS THE MOST COMMON ERRORS IN HOUSES THAT HAVE NOT BEEN BUILT BY PROFESSIONALS. THESE HOUSES ARE NOT SAFE DURING EARTHQUAKES



#### POOR-QUALITY MATERIALS

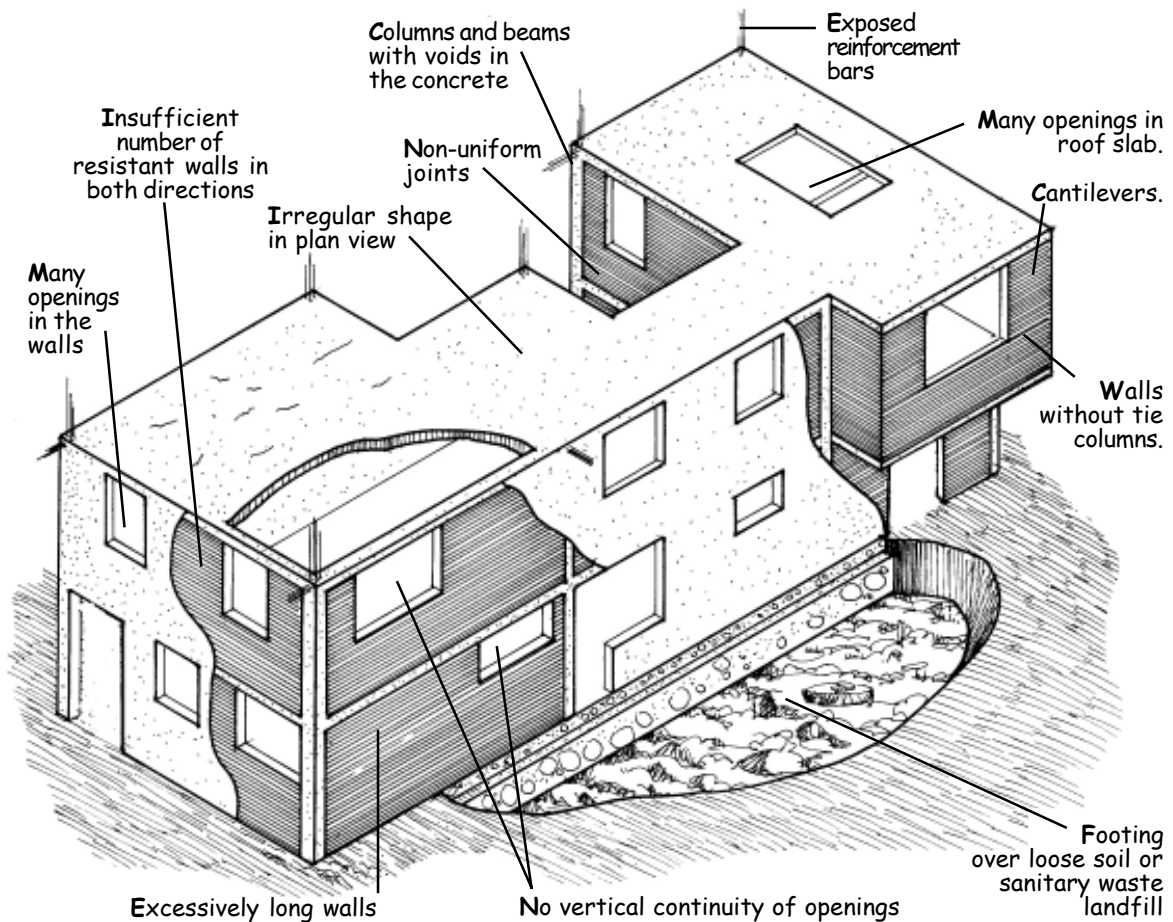

## 6 • The safe house

### QUALIFIED MANUAL LABOR

Civil Engineer or Architectural engineer



Master Craftsman

THIS DRAWING SHOWS THE CHARACTERISTICS OF A WELL-DESIGNED, SAFE HOUSE



### GOOD QUALITY OF MATERIALS



Use good-quality materials. "Saving expenses" by purchasing doubtful quality materials, never pays.

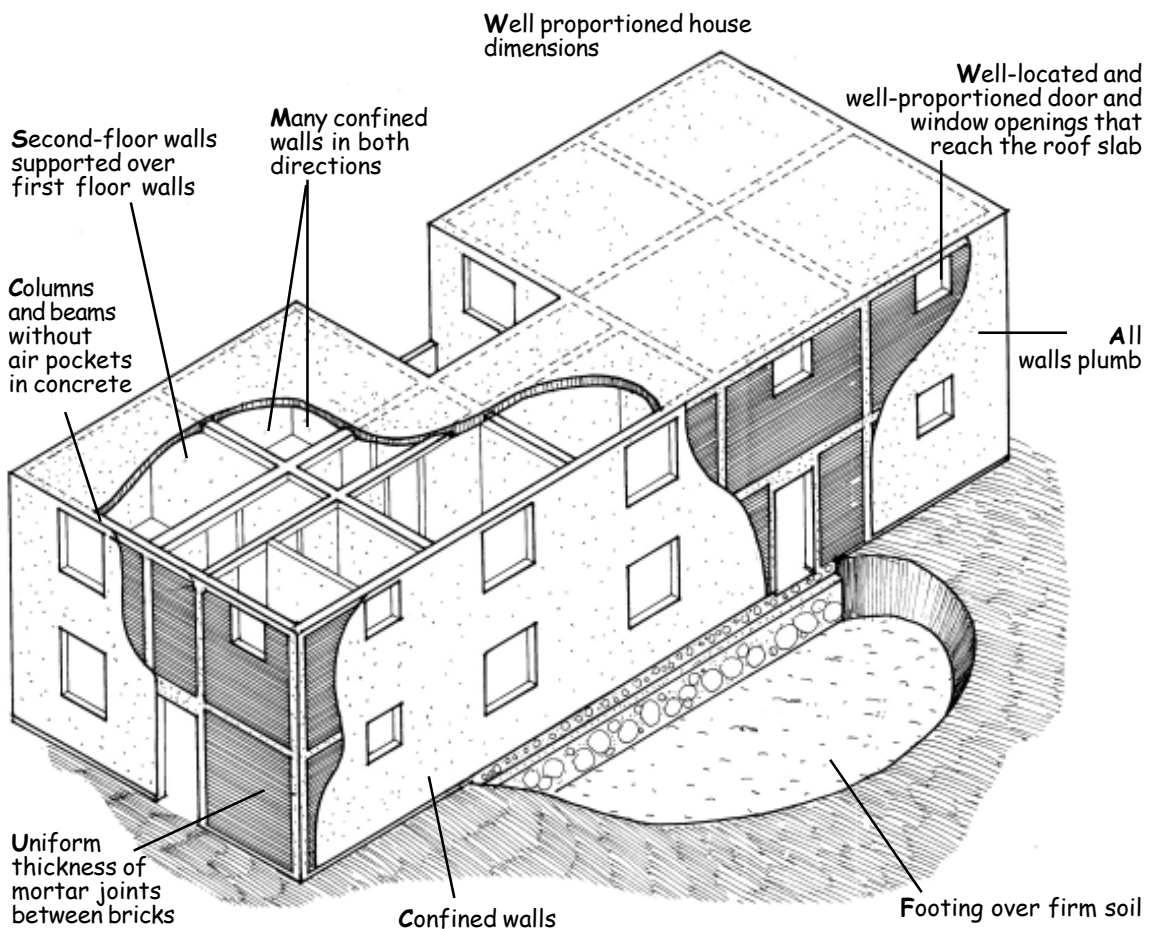

## 7 • Components of the Building Utilities

A well conceived house should have functional electrical and plumbing utilities. Here are the main components for each installation process.

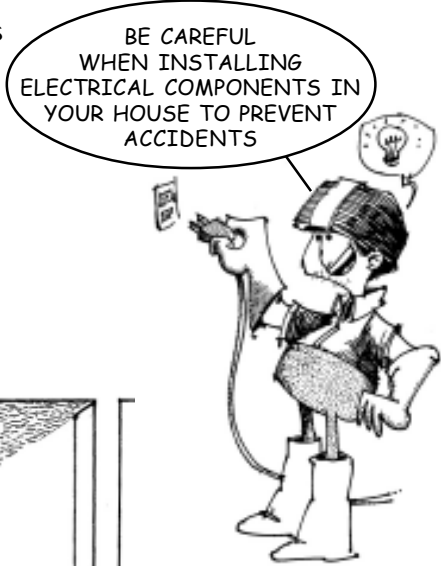

### ELECTRICAL SYSTEM

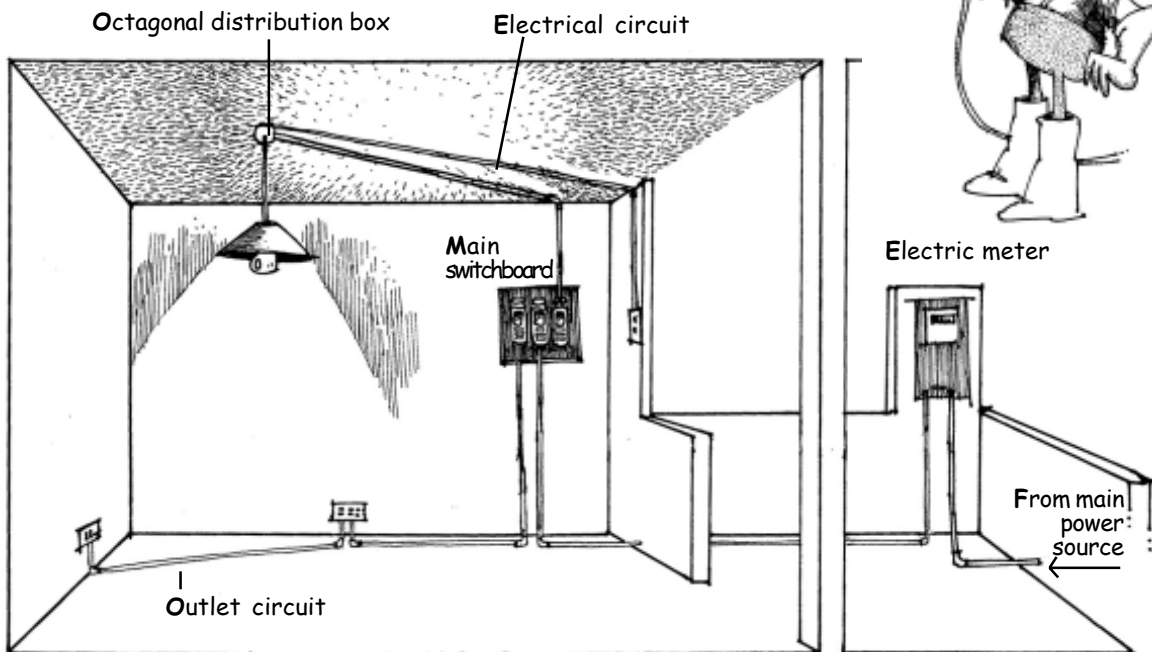

### WATER-SUPPLY SYSTEM

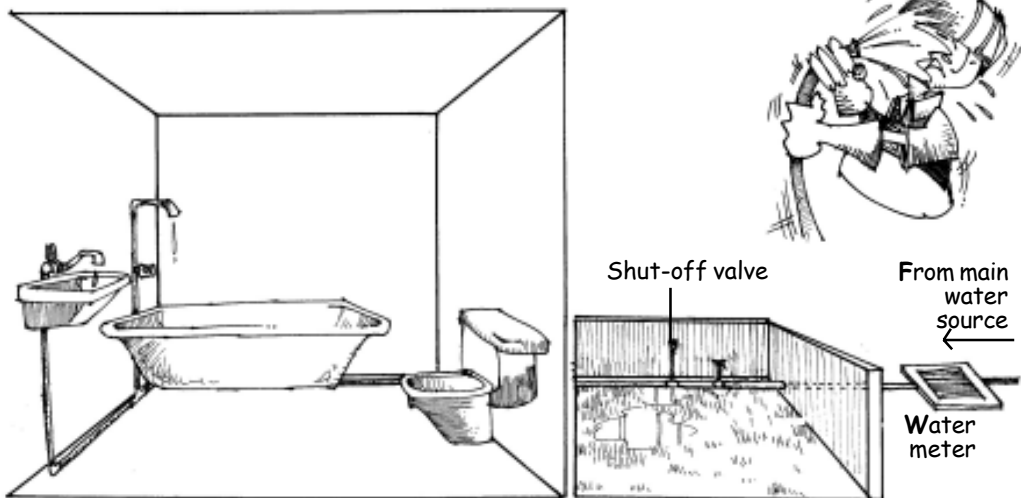
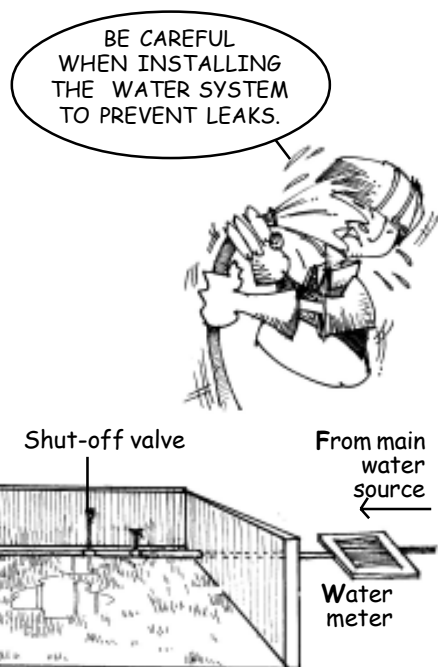

**SANITARY SEWER SYSTEM**

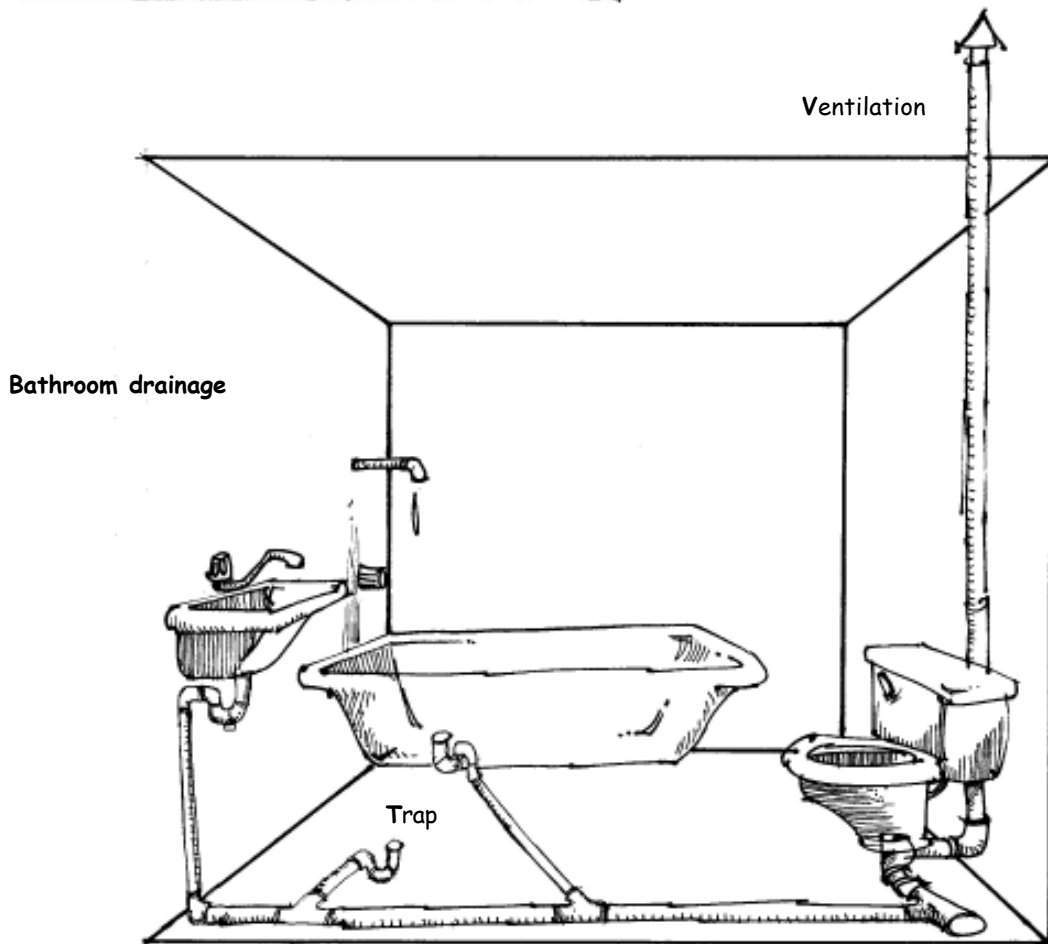
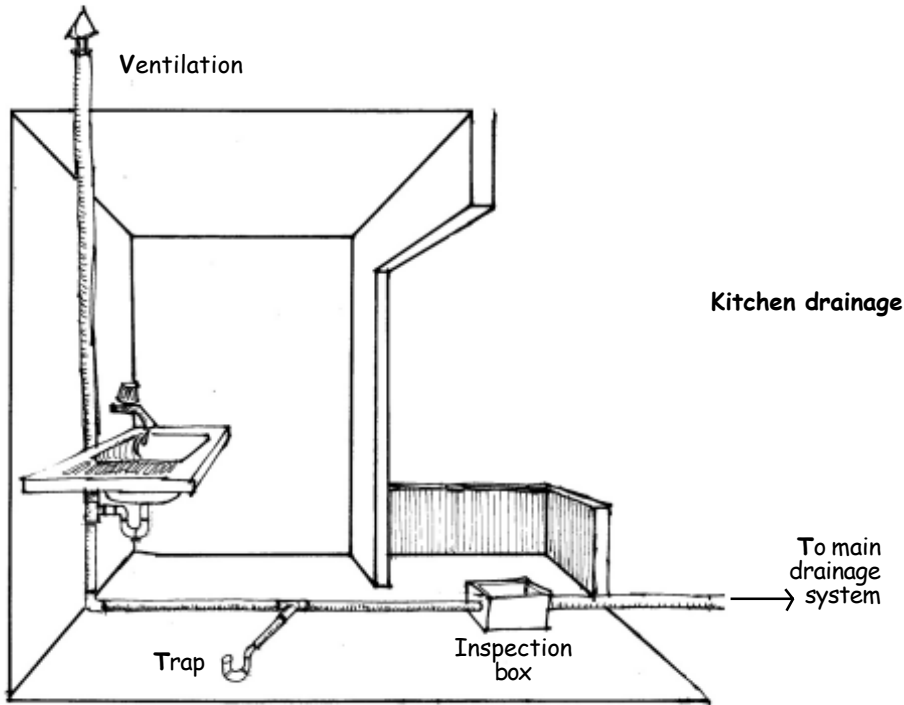



# 3 CONSTRUCTION OF A SAFE HOUSE

CHAPTER

## 1 • Drawings and permits (or other administrative procedures)

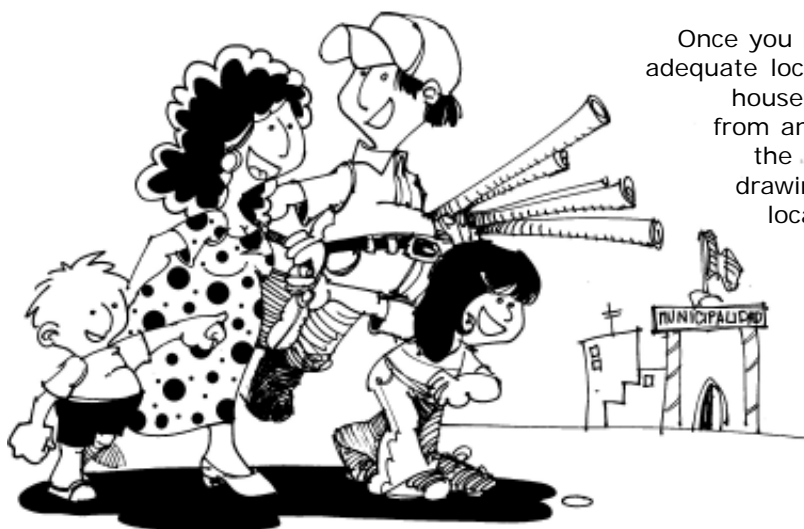

Once you buy your parcel of land in an adequate location, you must design your house. If it is possible, get advice from an engineer or an architect for the design of the house and the drawings. You can approach your local municipality to obtain help with your drawings and to find out if your house can also be used for a business. Remember that the construction of your house must be formalized by registering it in your town hall.

## 2 • Cleaning and leveling the land

Before starting work, clean the ground well. Remove all trash, construction debris, organic material and loose soil.



Organic material is bad for construction.

### Leveling the land

The construction site must be level, and above the drainpipes for your area. To level the site you must cut and fill the ground, so that ultimately it is completely flat at the required level.

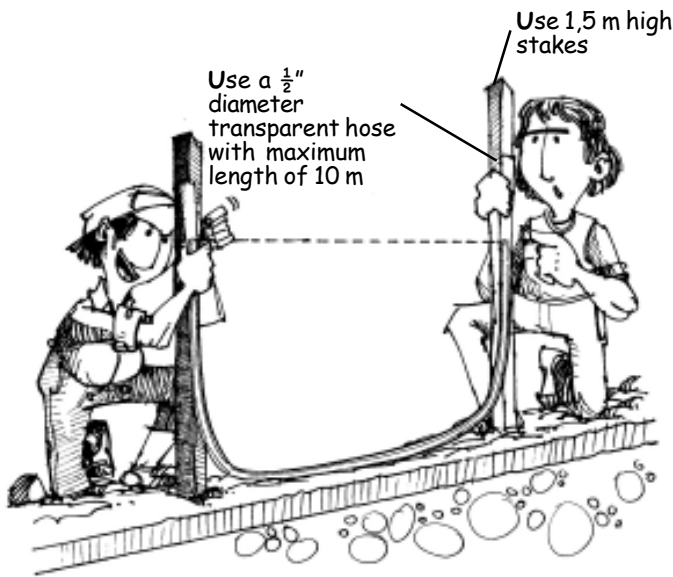
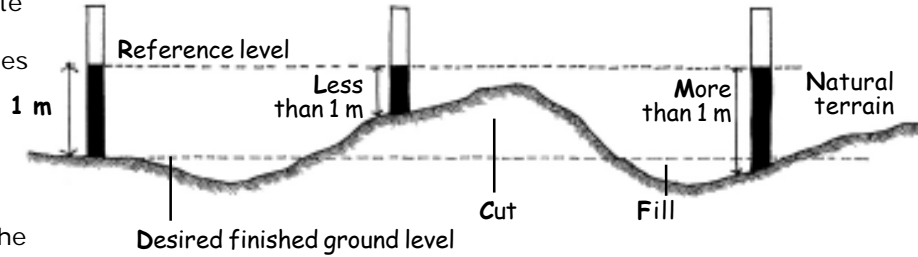

### "Run the level"

- 1** Fill the hose with clean water and verify that there are no bubbles.
- 2** Place stakes along the perimeter of your site and verify that they are plumb.
- 3** Use a stake to identify a reference point level such as the level of the street. Mark a height of 1m above the reference level on this first stake.
- 4** Using the water level inside the hose, mark the height of the first stake on all the other stakes.

### Cut and fill

After marking all the stakes, measure on each one the distance between the mark and the level of the natural terrain.

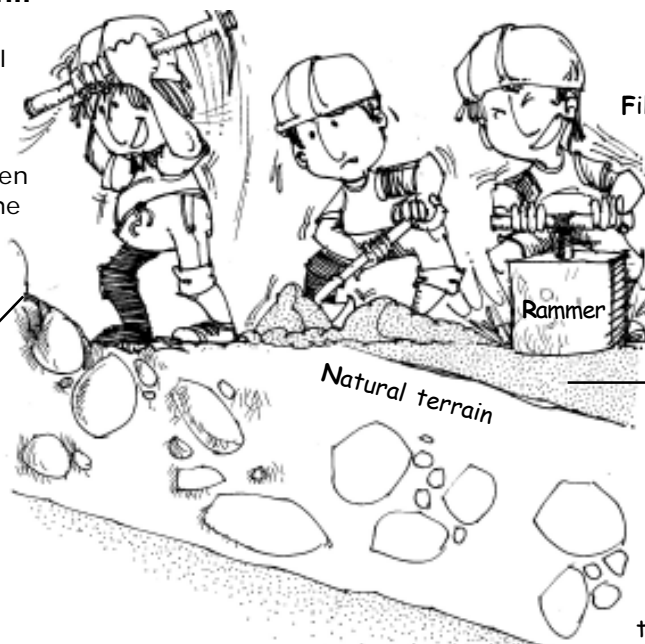

**Cut**  
When the distances measured are less than 1 m

Fill and cut the terrain until the distance between the mark and the ground is 1 m

**Fill**  
When the distances measured are greater than 1 m

To fill the ground, place layers of soil 30 cm thick. Wet each layer with water and compact well with a rammer.

### 3 • Layout

The layout is used to show the position on the ground where the foundation of your house will be constructed. Construct several guideposts from wood stakes.

Place the guideposts according to the drawing dimensions so they define the edges of the building footing.

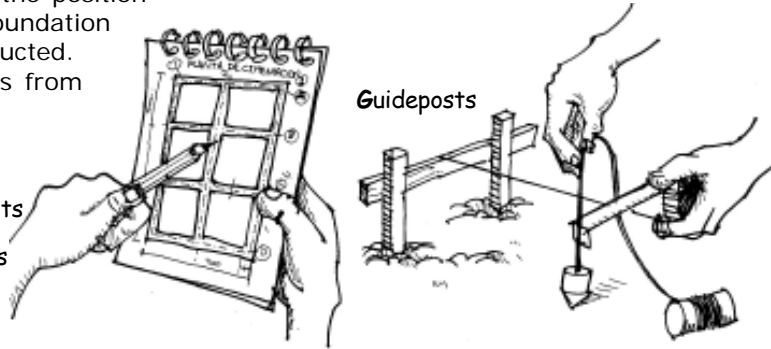

Locate the center of each footing and extend strings from each end of the guideposts limiting the width of each footing.

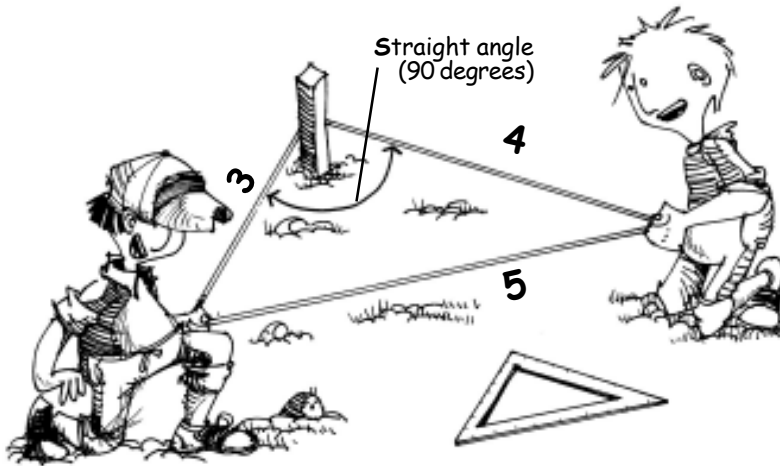

Use 3-4-5 triangles to verify that all walls are perpendicular (that is, all corners are right angles).

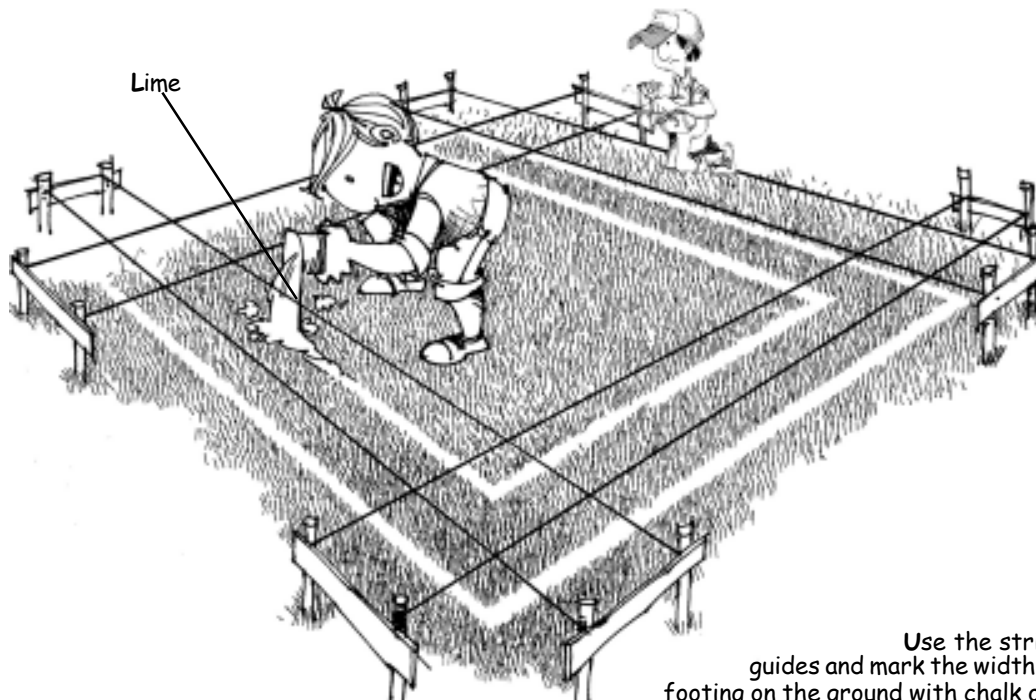

Use the strings as guides and mark the width of the footing on the ground with chalk or lime.



#### 4 • Construction of the Foundation

##### Continuous footing

In the following drawing you can see the minimum required footing dimensions.

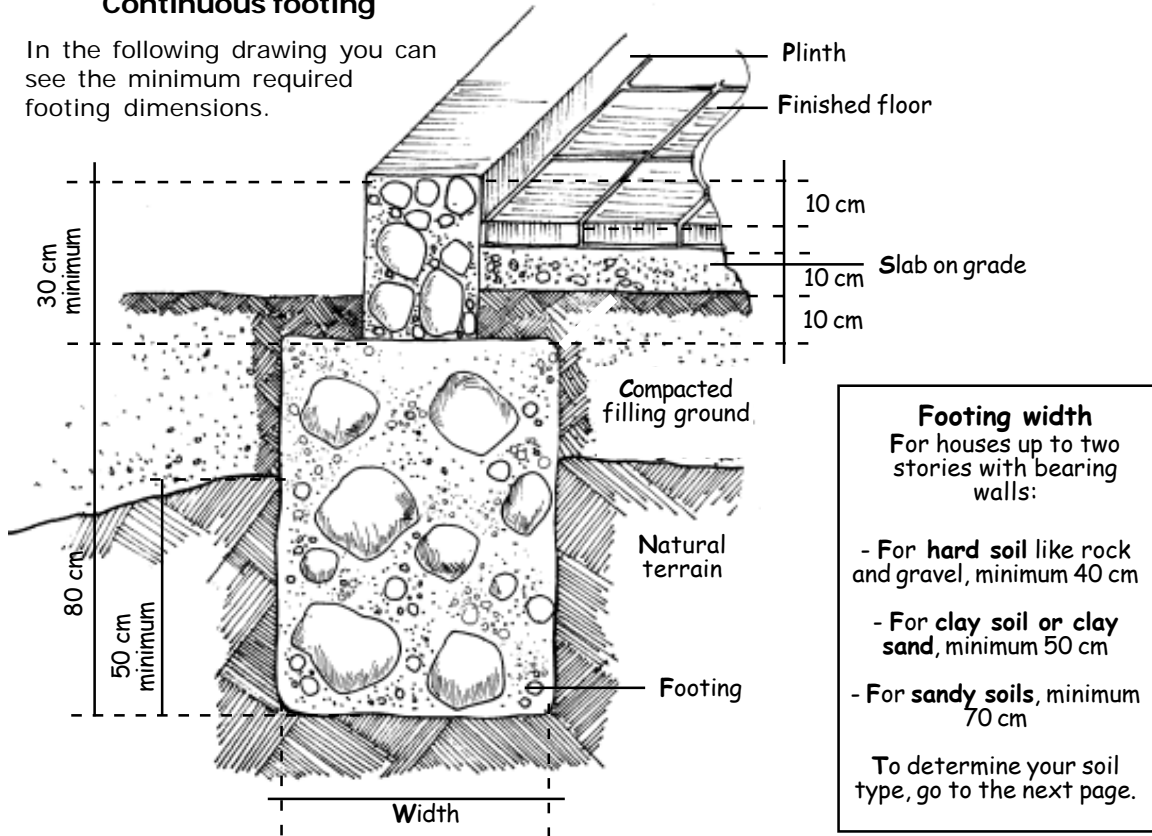

##### Stepped footing

Construct stepped footings when the terrain is sloped.

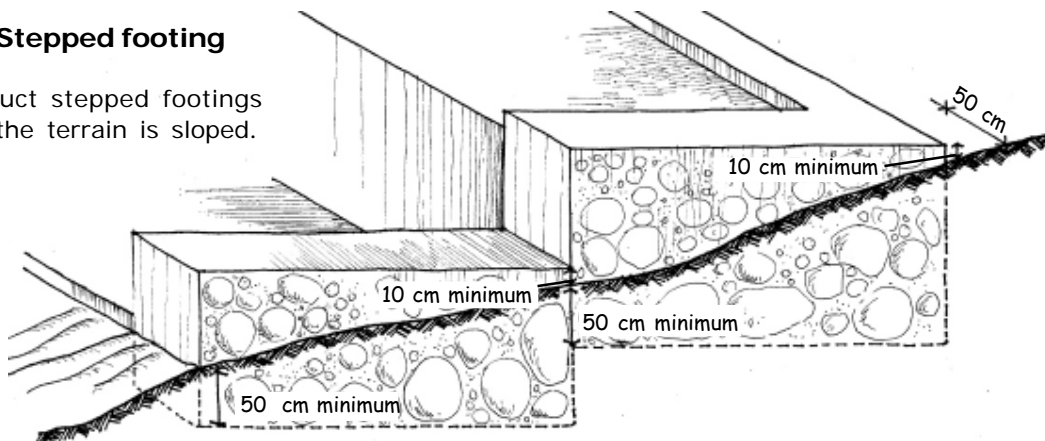

##### Recommendations

Hard soils such as rock or gravel are the best foundation soils. Gravel is made up of different size stones and coarse compact sands. Sometimes it is difficult to excavate these soils with a shovel and you have to use a large drill.

Find out about the footings of nearby houses. If nearby houses have settled under their weight, then your foundation should be wider and deeper than that of your neighbors.

**If your soil is not gravel or rock, how can you recognize what type it is?**

You can do this simple test.

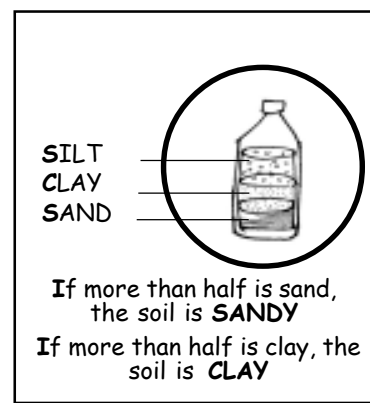
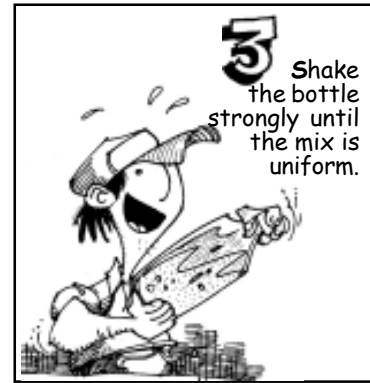

**Excavating the foundation trenches**

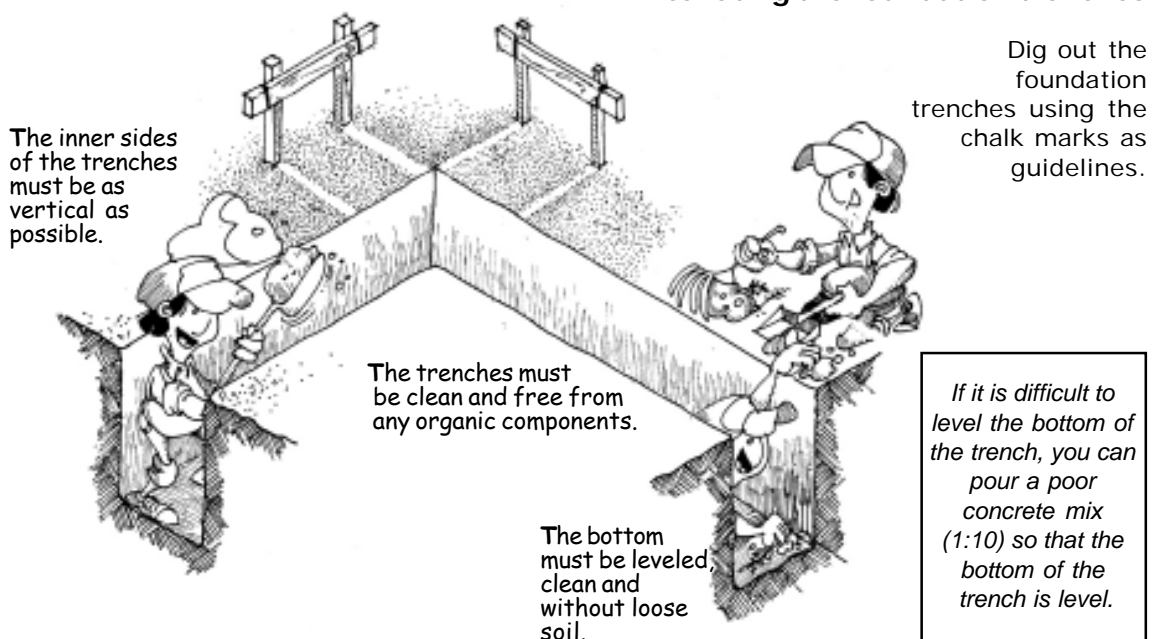

**Before pouring the footing**

**Standing column reinforcing bars**

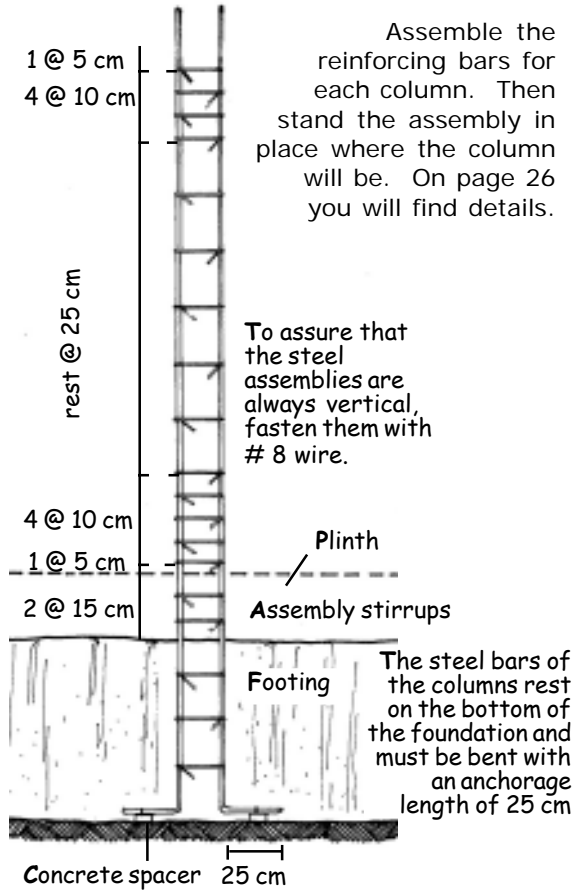

**Placing installations**

Have the utilities and plumbing for your house ready before laying the foundations. The pipes must **never** pass through any reinforced concrete element such as columns, beams or roof joists.

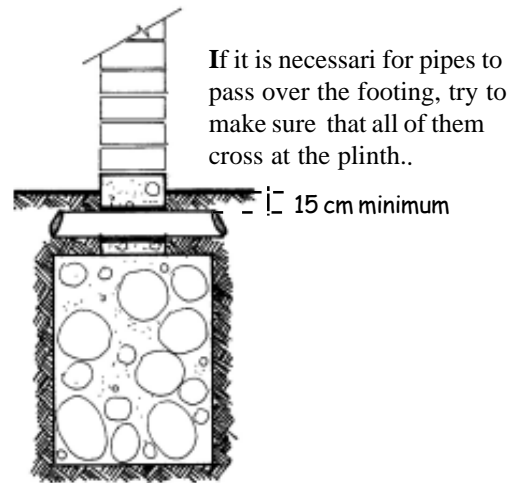
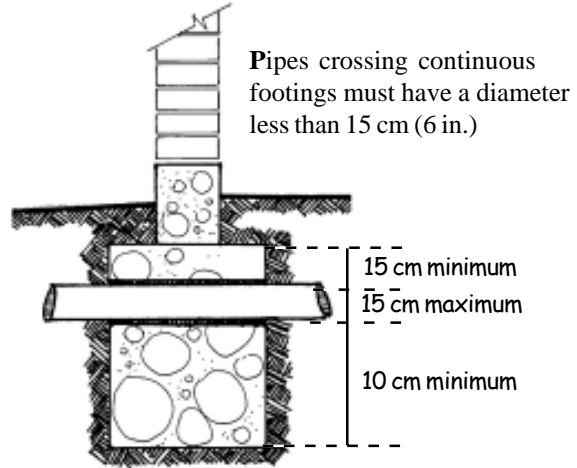

**Wetting the trenches**

Wet the trenches before pouring concrete for the foundation.

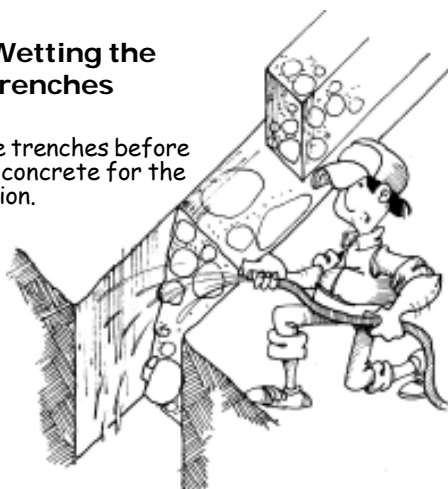

Always leave some tolerance in the footing so that pipes are not trapped.

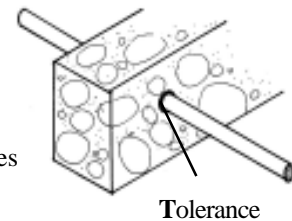

**Recommendations**

You can leave holes in the foundation for the pipes, using larger-diameter pipes. Before pouring concrete for the foundation, fill the pipes with sand and seal them temporarily. Never leave sand bags in the foundation to provide holes for crossing pipes.

### Pouring concrete for the foundation

It is better if you rent a small-capacity mixer to prepare concrete. This will help control quality and save materials. Pre-assess the people who will help you mix and pour the concrete.

Pour concrete for the foundation with wheelbarrows. As pouring continues, drop big stones in the foundation trenches.

Do not place big stones near the columns. Leave approximately 30 cm on each side of the column free of big stones.

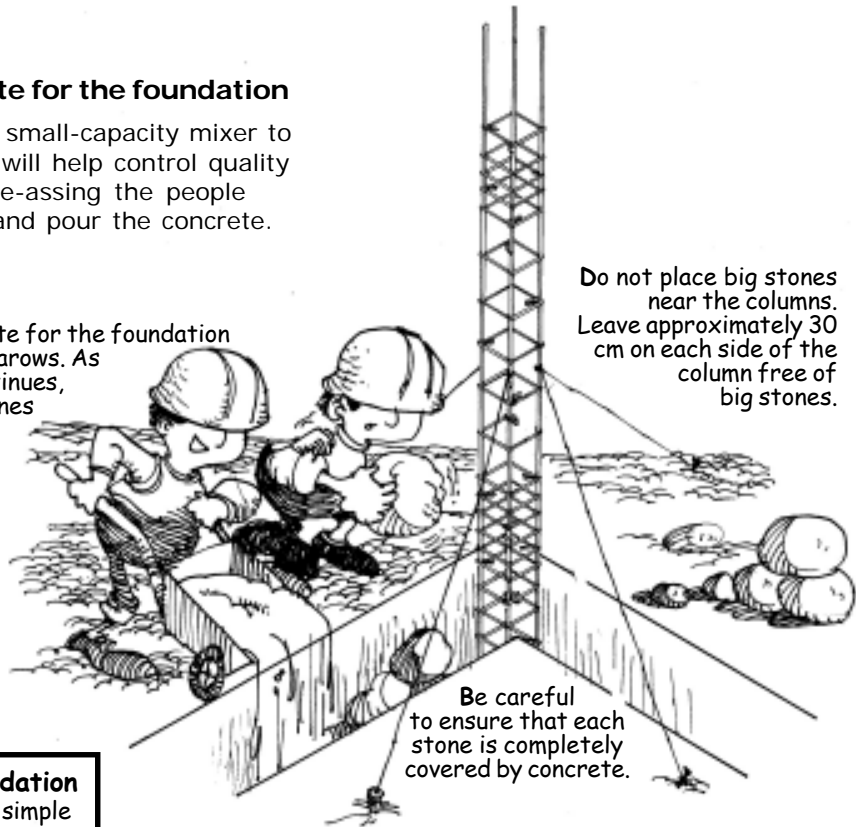

Be careful to ensure that each stone is completely covered by concrete.

#### Concrete for the foundation

Foundations are made of simple concrete.



1 bucket of cement



10 buckets of aggregate



30% in volume of big stones (maximum size 10 in.)



1 1/2 buckets of water



Remember that the concrete must not remain rotating in the mixer for more than 3 minutes.

### Steel reinforcement in the plinth

If your soil is sandy or clayish, it is better to place steel reinforcement in the plinth.

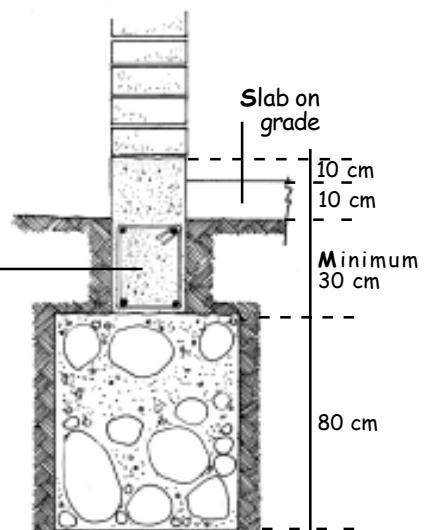
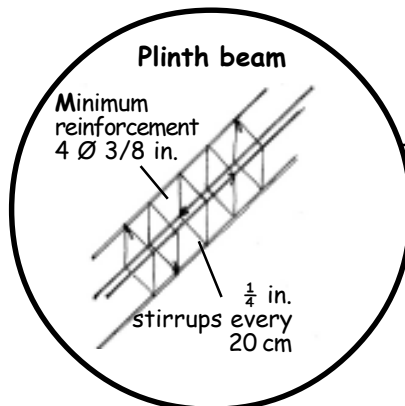







### Concrete for the plinth

You can hand mix the concrete for the plinth. Clean a flat area where the mix will be prepared. A concrete floor is desirable. Mix the dry materials and then add water. If the mix is not workable, you can add a little more water. Wet the forms with water before pouring. To pour the concrete you can use buckets or wheelbarrows. Remember not to place big stones in areas near columns.





**Concrete for plinth in firm soil**

The plinth does not require steel reinforcement.

-  1 bucket of cement
-  8 buckets of aggregate
-  25% in volume of medium size stones (maximum size 4 in.)
-  1 1/4 buckets of water

**Concrete for plinth in loose soil (sand or clay)**

Build a reinforced plinth to prevent cracking of the walls due to settlement of the ground soil.

-  1 bucket of cement
-  2 buckets of aggregate
-  4 volumes of crushed stone (maximum size 3/4 in.)
-  1 bucket of water

### The plinth

When you finish pouring concrete on the plinth, scratch the upper surface with a nail so that the mortar of the first layer sticks well.

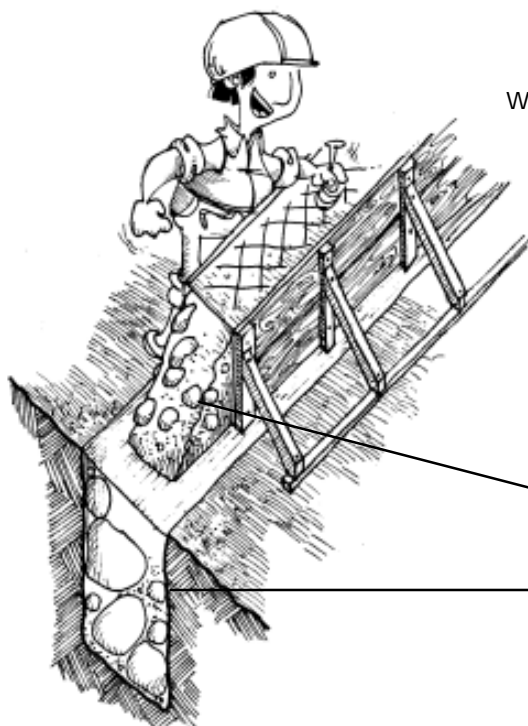

**Construction joints**



If you need to stop pouring concrete on the foundation or the plinth, leave a diagonal joint with exposed stones.

**5 • Column rebar assembly**

**Dimensions**

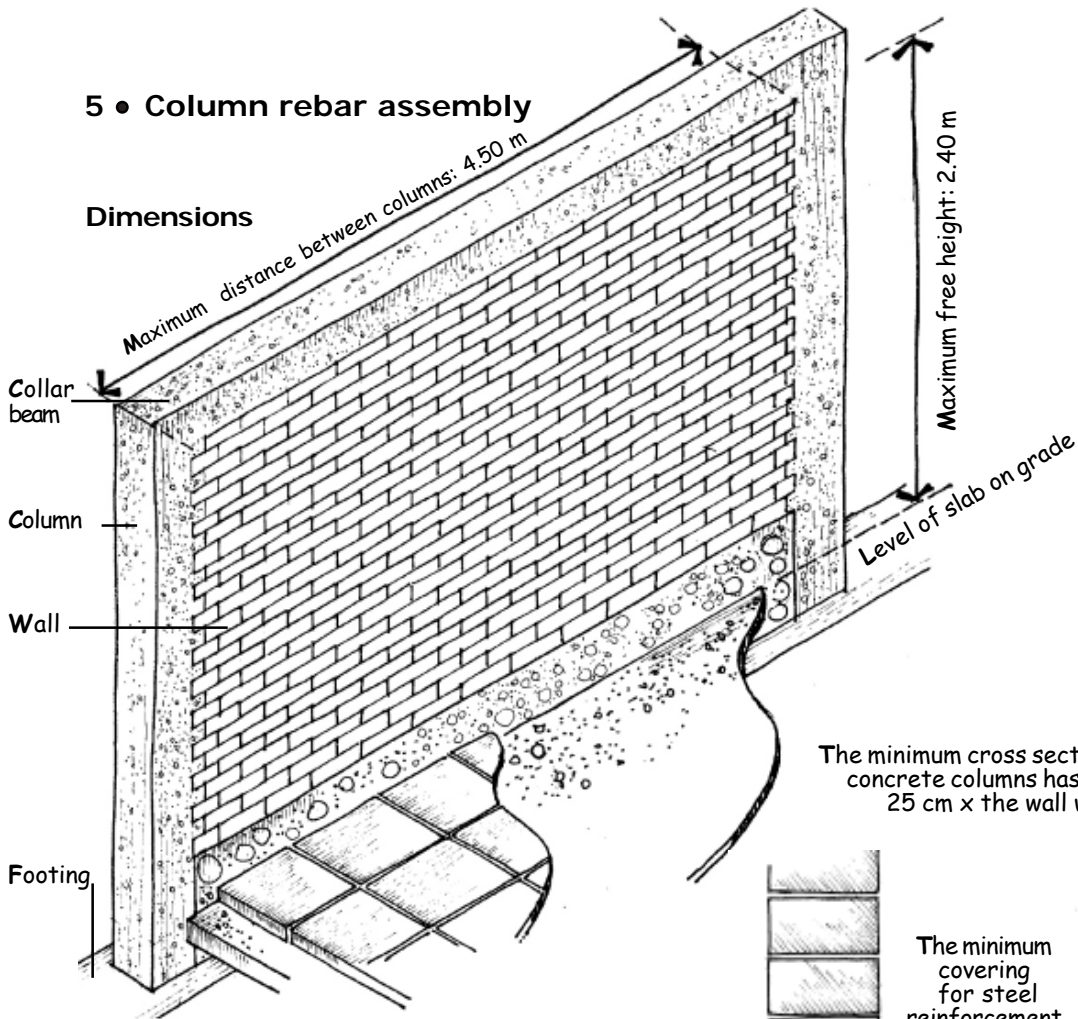

**Reinforcement**

Minimum reinforcement for columns is 4 j 3/8 in. steel bars. Column stirrups are 1/4 in. and have to be placed with the following spacing: 1 @ 5 cm + 4 @ 10 cm + the rest @ 25 cm on each end. The distances between stirrups are measured starting from the plinth upwards and from the collar beam downwards.

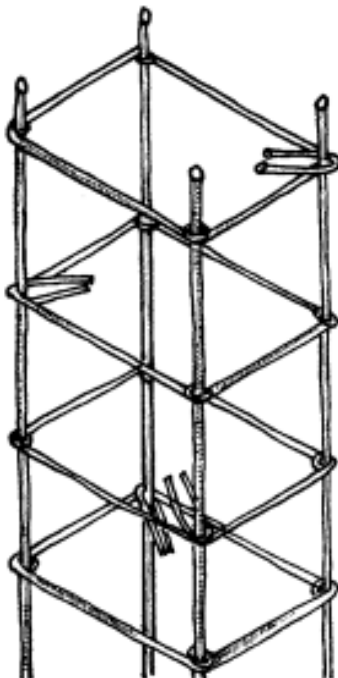

Try to alternate the position of the stirrup's hook, so that it is not located in the same corner of the column.

The minimum cross section of concrete columns has to be 25 cm x the wall width.

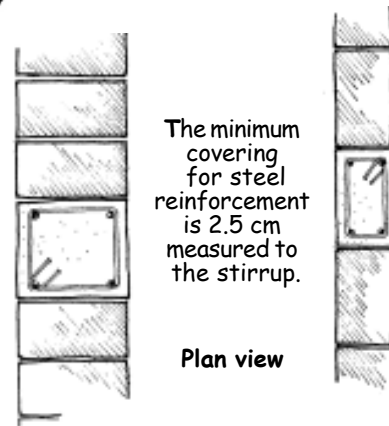

Header wall (long direction of brick perpendicular to the plane of the wall)

Stretcher wall (long direction of brick parallel to the plane of the wall)

**Stirrup bending**

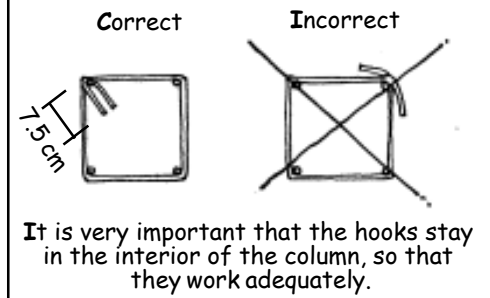

**Rebar splices in columns**

Never lap splice 4 bars in the same-cross section along the column because this weakens the column.

**NO**

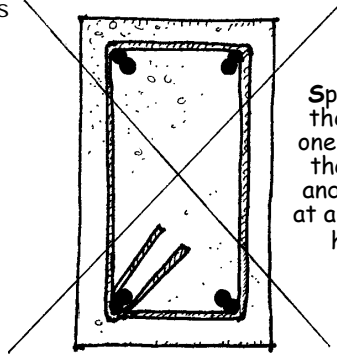

100 % splices in one cross section

**YES**

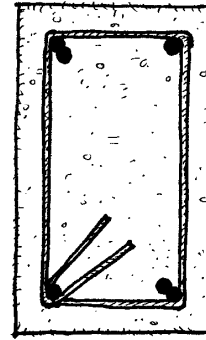

50% splices in one cross section

Splice half the bars at one height of the column and the rest at a different height.

The minimum concrete covering for the stirrup is 2.5 cm

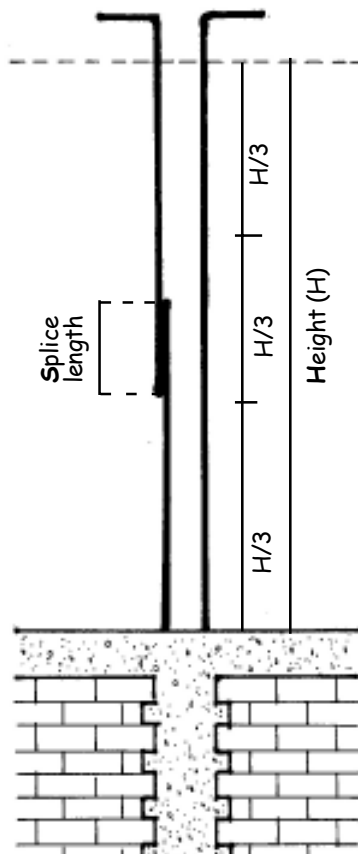

Connect the steel bars within the central third of the free height of the column.

Steel	Splice length
3/8 in.	40 cm
1/2 in.	50 cm

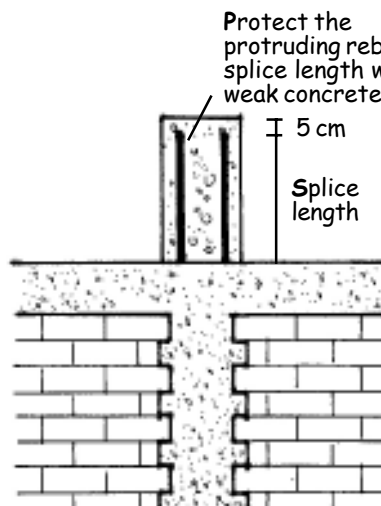

If you build only the first floor, leave protruding rebar for future construction of the second floor.

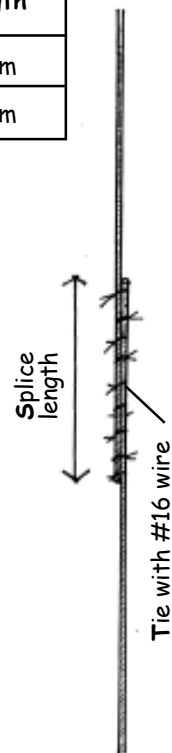

**Recommendation**  
Never weld steel reinforcing bars.



## 6 • Walls

### Preparing the bricks

The day before building the walls, clean the bricks and water them for 20 minutes. Then, let them rest.

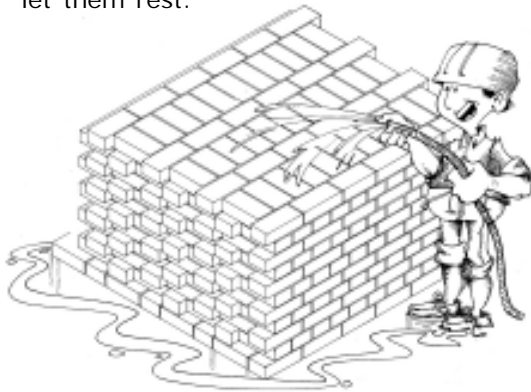

### First course

Before setting the first layer, place the bricks without mortar to determine the brick setting pattern.



First, dry mix the cement and the sand.

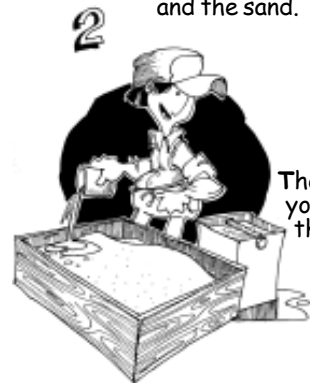

Then add water as you continue with the construction of the walls.

### The mortar

To prepare mortar use one bucket of cement with 5 buckets of clean coarse river sand.

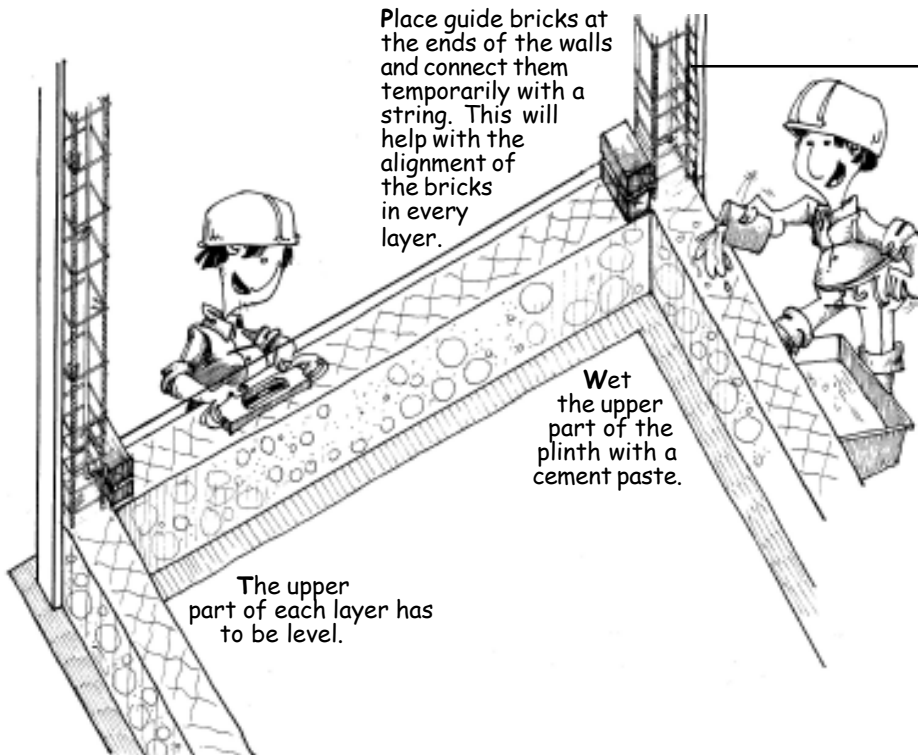

Place guide bricks at the ends of the walls and connect them temporarily with a string. This will help with the alignment of the bricks in every layer.

Wet the upper part of the plinth with a cement paste.

The upper part of each layer has to be level.

### Straightedge

Wooden straightedge

Place straightedges to control the width of horizontal joints.

### Recommendation

Always use fresh mortar. Do not use mortar that is starting to harden.

### Constructing the wall

For the construction of the first course, place mix uniformly over the plinth using a bricklayer's trowel. Set the bricks over the mix and verify that their edges touch the strings that connects the guide bricks. To set successive layers, place the mix over the immediately below and fill the vertical joints completely.

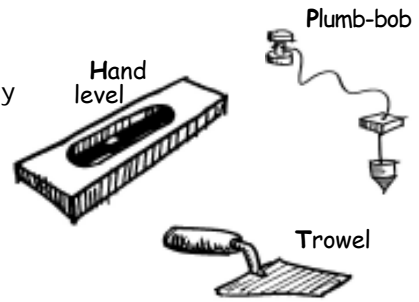

### Placing the mortar

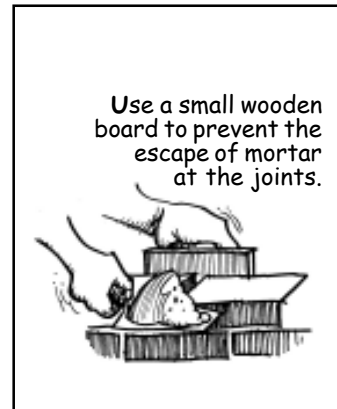
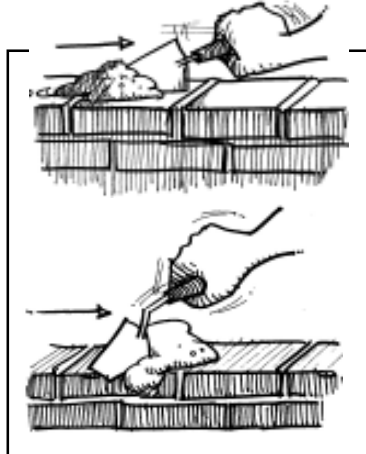
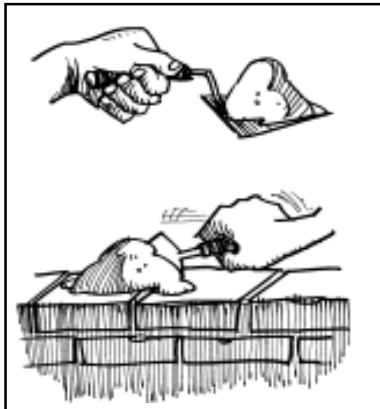

### Placing the bricks

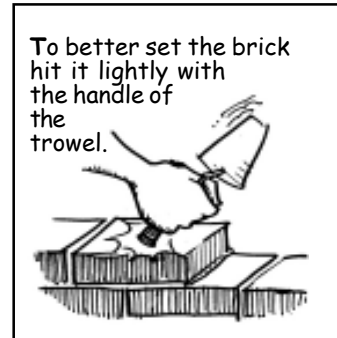
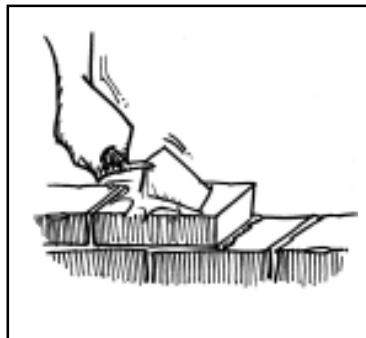
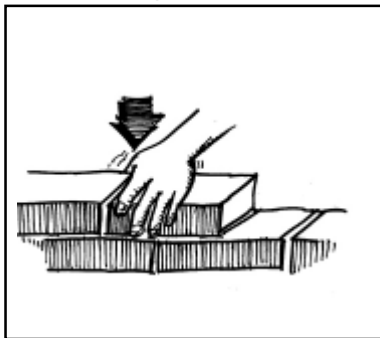

### Horizontal and vertical joints

Do not leave joints more than 1.5 cm thick. Joints that are too thick will weaken the wall.

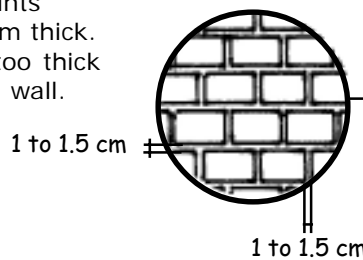

### Level control

Use the plumb-bob at every layer to make sure the wall is vertical.



**Daily progress**

Do not raise the wall more than 1.20 m high each working day. If you raise a greater wall height, it might fall because the mortar mix will still be fresh.

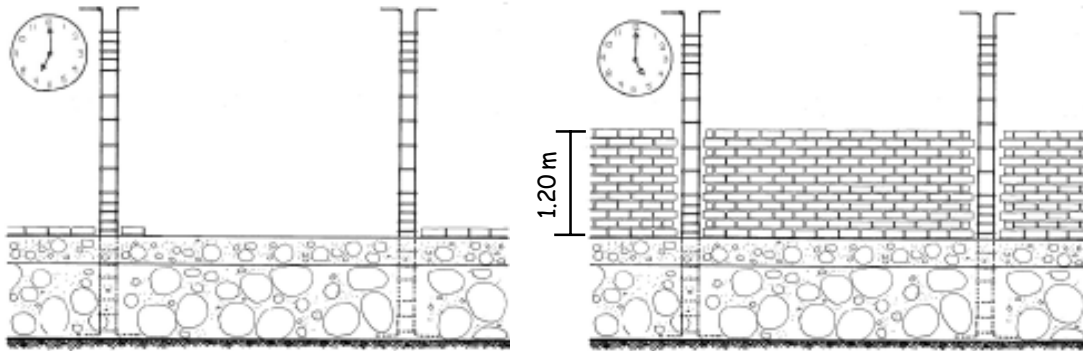

**Column-wall connection**

Leave toothed edges at the sides of the wall next to every column to provide adequate confinement for the wall.

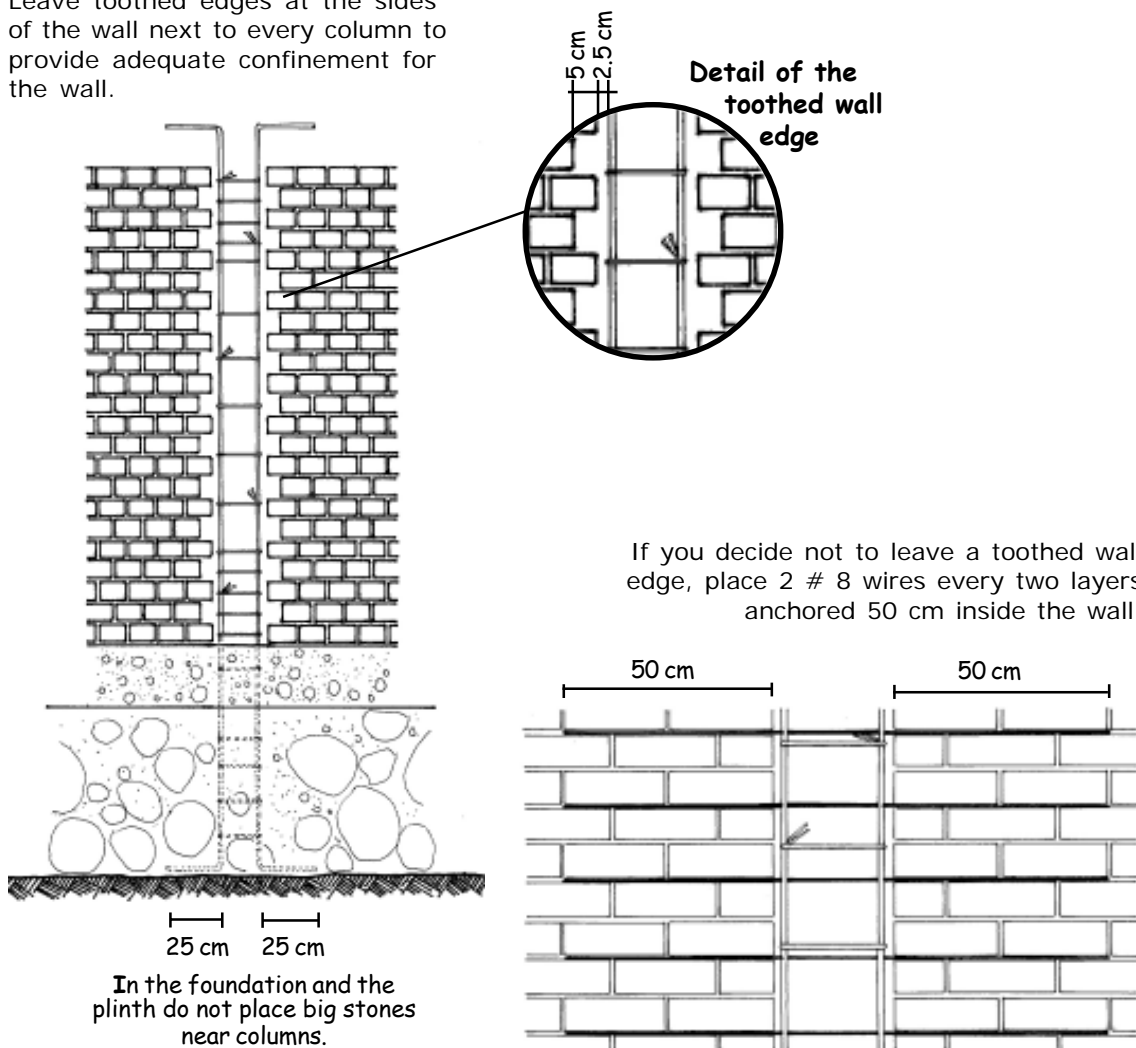

In the foundation and the plinth do not place big stones near columns.

**Electrical installations in the walls**

Embed electrical conduit inside false columns that are formed between toothed walls, without steel and filled with 1:6 concrete.

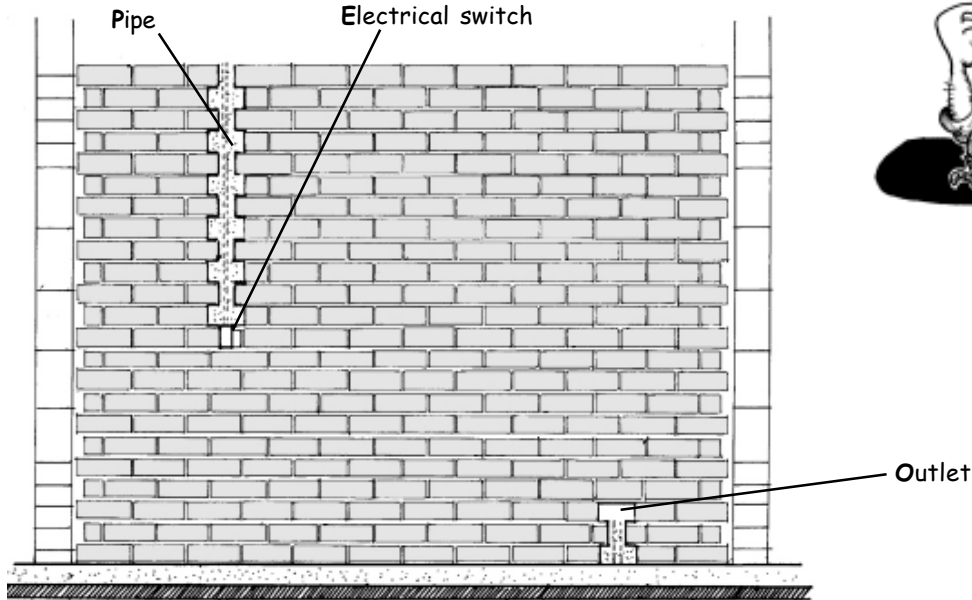
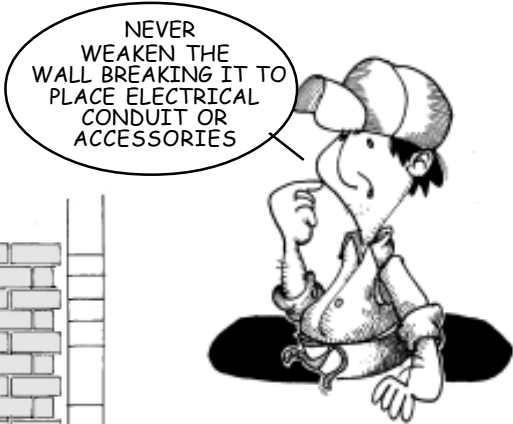

**Drain and ventilation pipes**

Embed the drain and ventilation pipes inside false columns that are formed between the toothed walls. Place #8 wire every three layers and wrap the pipes with #16 wire.

Fill the false columns with 1:6 fluid concrete.

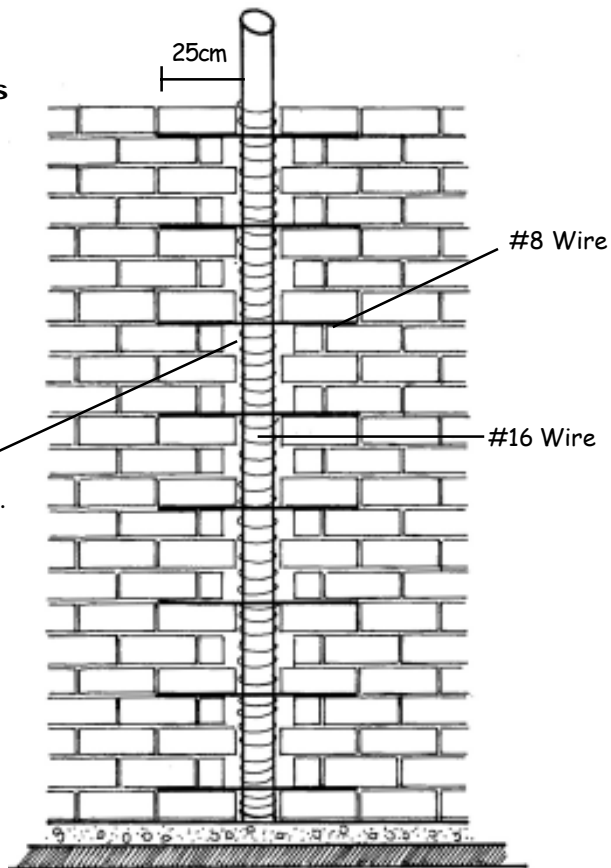



## 7 • Pouring concrete in confining columns

### Formwork and pouring

After the walls are built, attach formwork to the walls for the confining columns. It is better if you use a portable concrete mixer to prepare concrete for columns. Use buckets to carry the concrete mix from the mixer to the upper part of the formwork. Carefully pour the concrete inside the forms.

To prevent the appearance of air pocket in columns use a concrete mix with less stone in the first batches.

Vibrate concrete with a long rod to prevent air pockets.

Lightly hit the form externally with a rubber hammer.

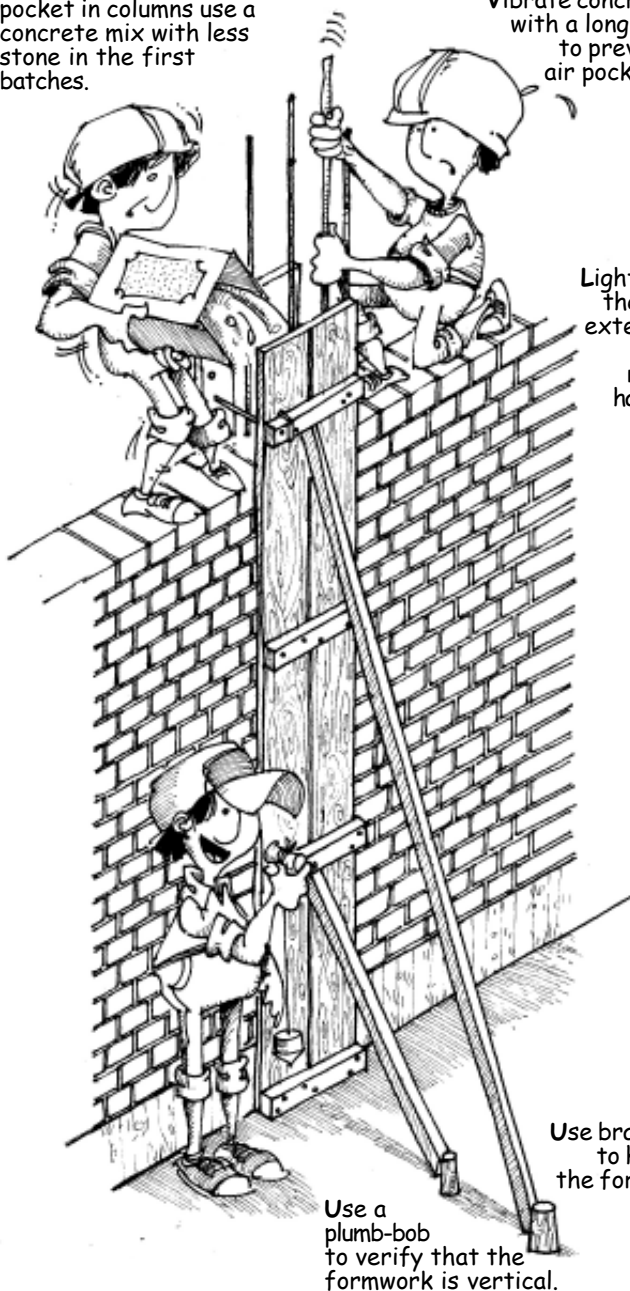

Use a plumb-bob to verify that the formwork is vertical.

#### Concrete for columns



1 bucket of cement



2 buckets of coarse sand



4 buckets of crushed stone  
(maximum size  $\frac{3}{4}$  in.)



1 bucket of water

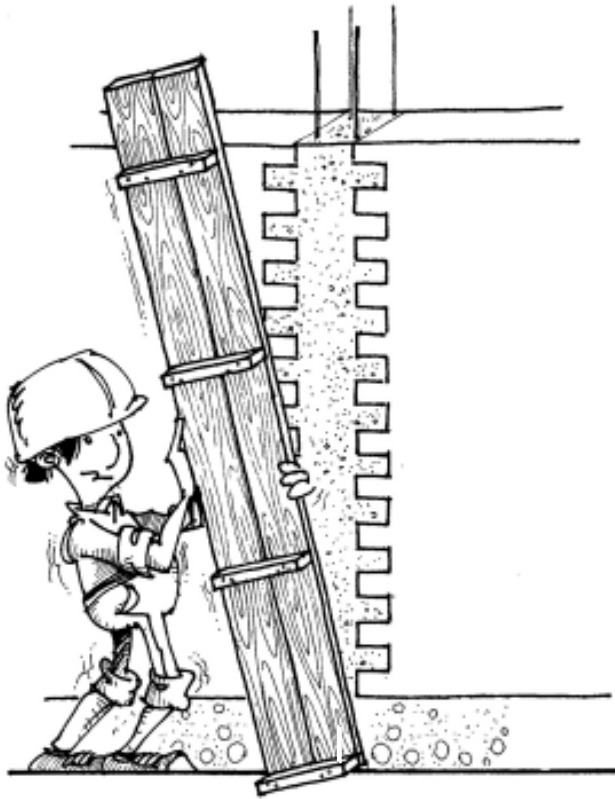

### Formwork removal

After pouring concrete into the columns, leave the forms up for 24 hours. Then carefully remove the forms and use them again for other columns.

### Curing

Cure concrete after removal of the forms from the columns. Curing consists of watering the concrete elements at least 3 times a day to improve hardening of cement.

Cure every concrete element for at least 7 days.

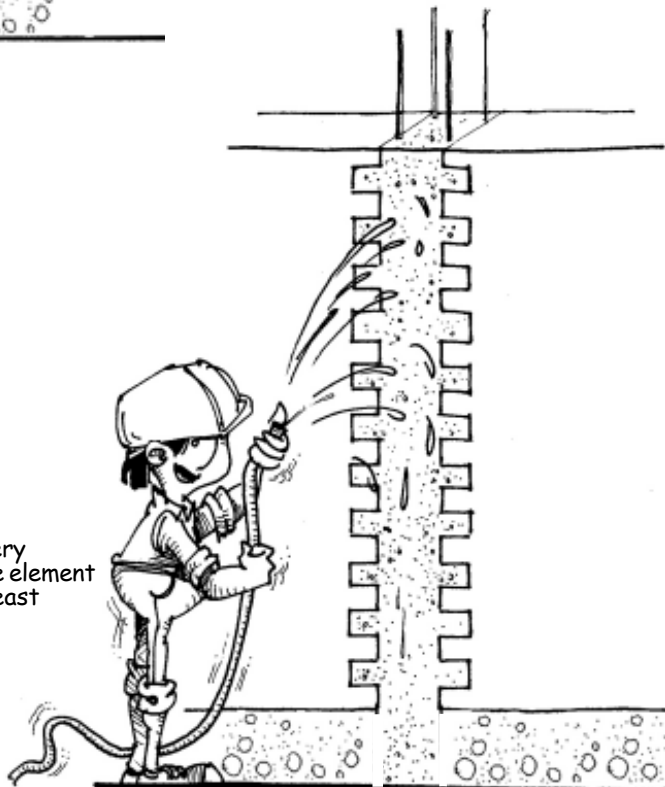

### Recommendation

If a column has a large number of voids, immediately break and remove the concrete, carefully clean the steel bars, replace the formwork and pour again the concrete again.

## 8 • Confining beams

The confining beams of your house are important because they help confine the walls.

**Collar beams** are the beams on top of the walls.

### Minimum reinforcement

Minimum reinforcement of all beams is: 4 steel bars  $\varnothing$  3/8 in. with 1/2 in. stirrups spaced 1 @ 5 cm, 4 @ 10 cm and the rest @ 25 cm from each end.

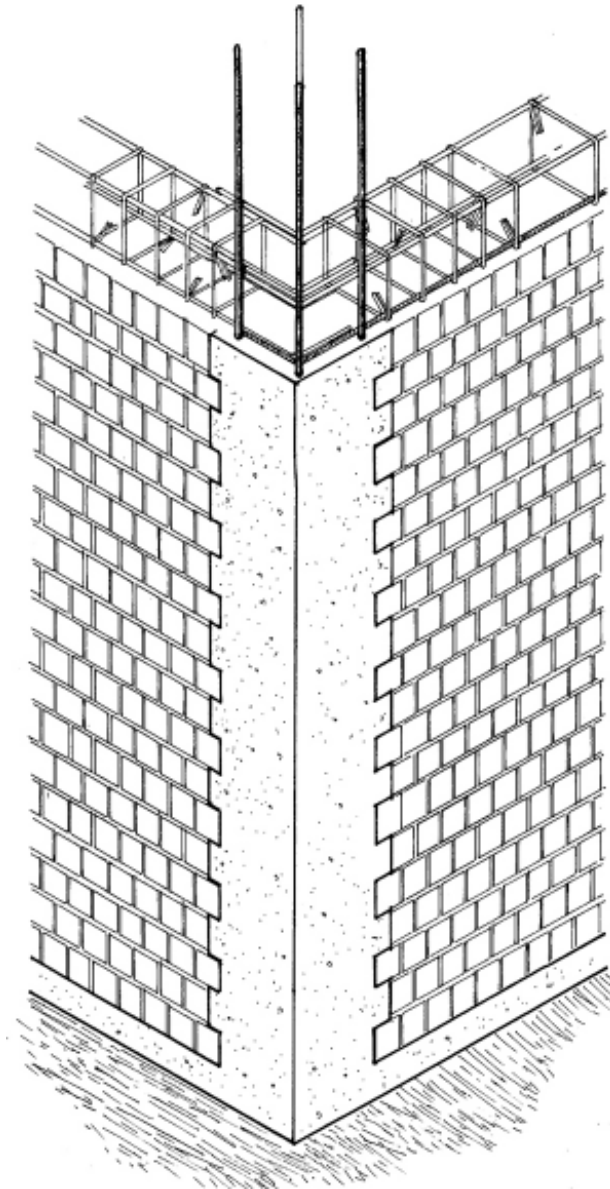
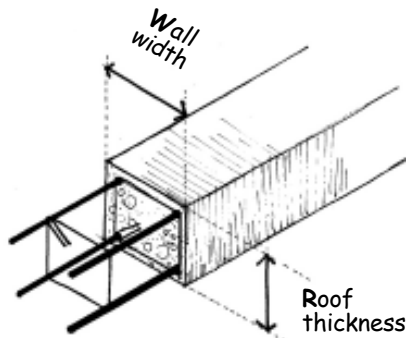

### Deep beams

Deep beams are used to resist the weight of partition walls or of the roof. They transmit the load to columns and walls. The depth of these beams is greater than the thickness of the slabs.

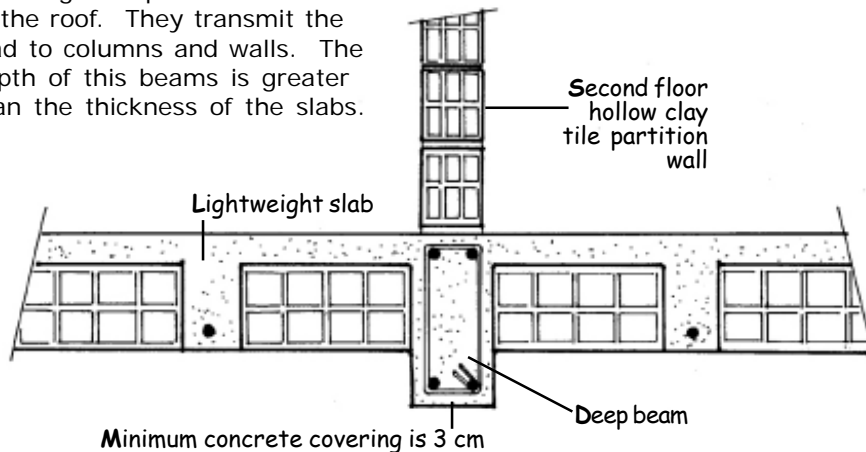

The minimum depth of these beams is the free span divided by 14. Deep beams usually do not have a wall underneath.



**Flat beams**

Flat beams are inside the slabs and help to transmit the weight of partition walls to the columns and bearing walls. It is better not to have flat beams longer than 4 m.

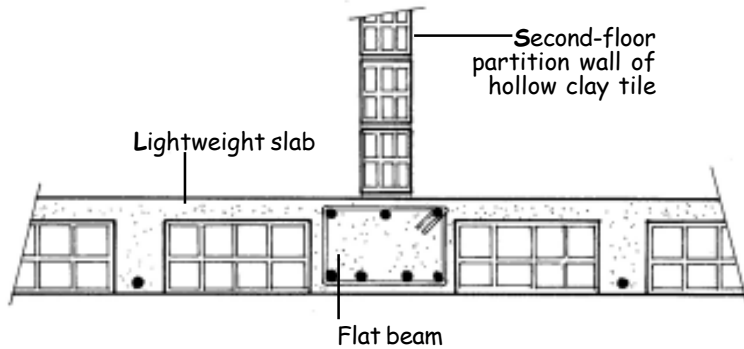

**Reinforcement of flat beams**

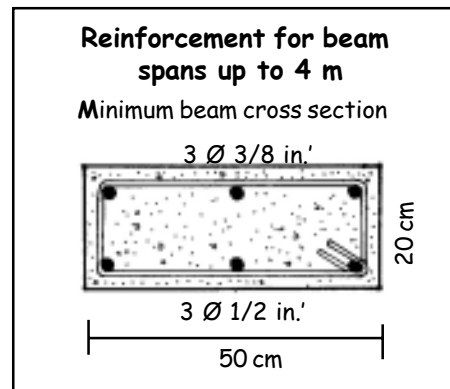
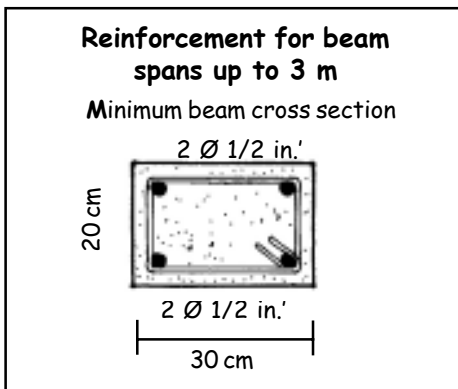
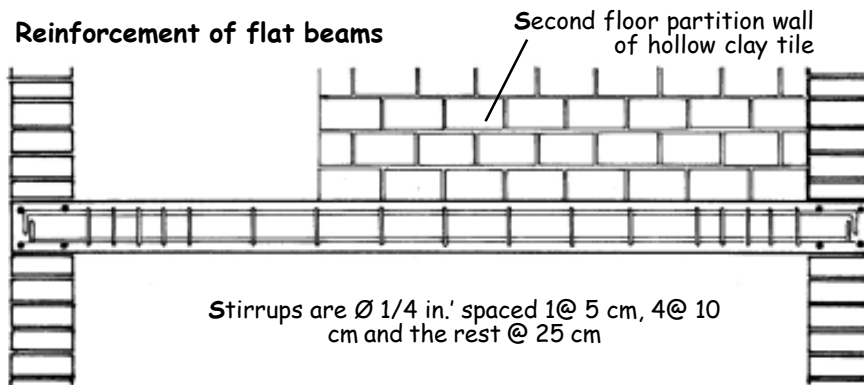

**Rebar splices in beams**

Be careful when you splice reinforcement bars in beams. Upper reinforcement bars must be spliced at the center of the beam span. Lower reinforcement bars must be spliced near the ends of the beam.

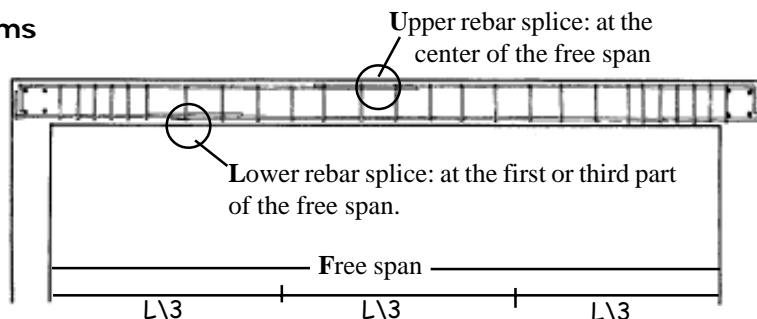

**Recommendations**

Stirrups are measured from the inner face of the wall. Minimum concrete covering for deep beams is 3 cm measured from the stirrup and for flat beams is 2.5 cm

### Beam-column connection

Carefully place reinforcement bars at beam column intersection. When you pour concrete in these areas, vibrate concrete extensively with a rod so that no air pockets are formed.

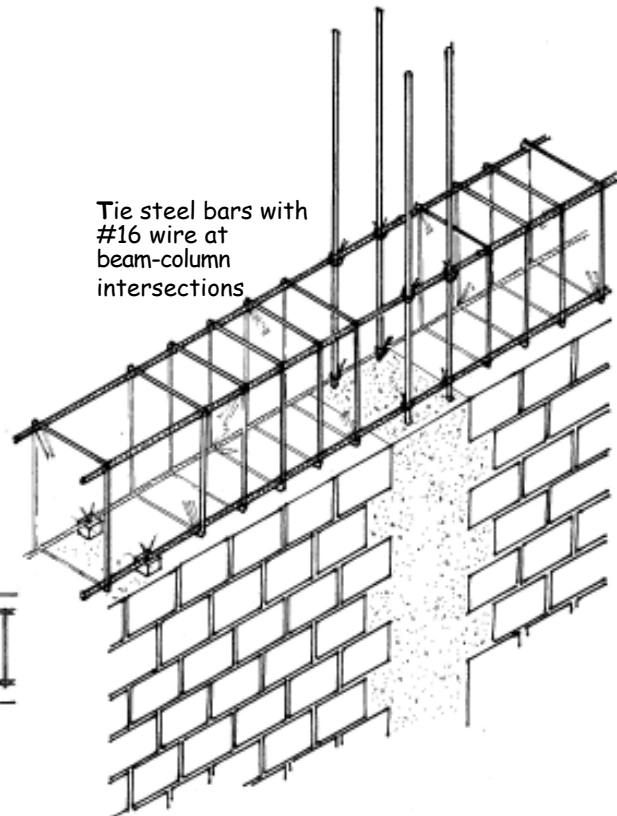

Detail of plan view

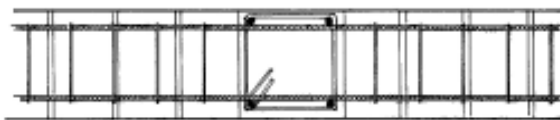

In case the beam is not continuous, bend the steel bar horizontally.

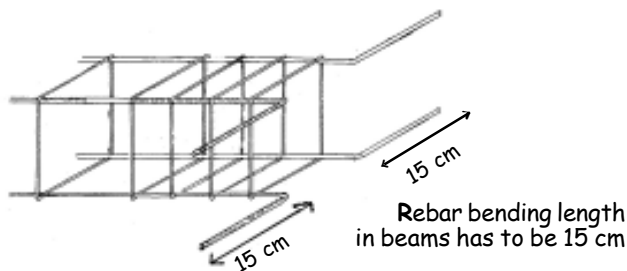

### Spacers for beams

To keep beam reinforcing bars in horizontal position, place mortar cubes 3 cm side under them.

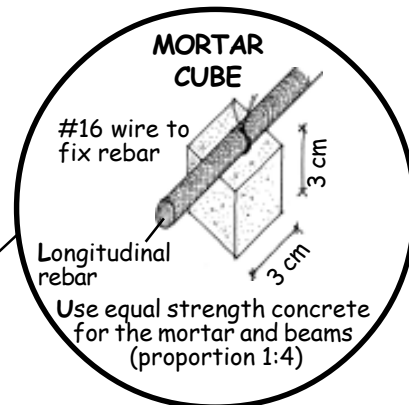
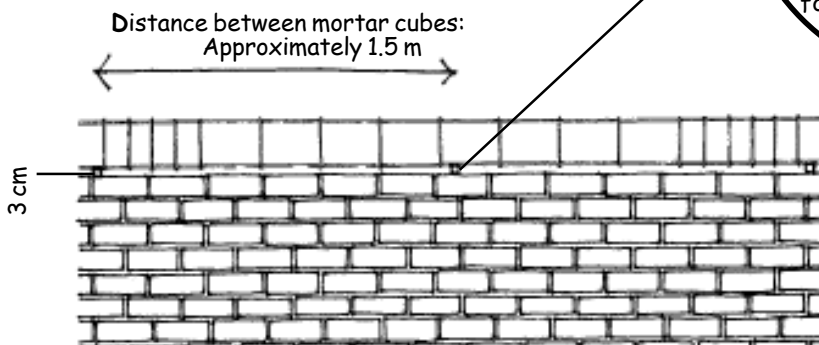

### Incorporating lintels into the beam

Door and window openings should go up to collar-beam level. Here are three ways of making lintels over these openings.

#### Alternative 1 (highly recommended)

Beam with greater depth and confinement columns.

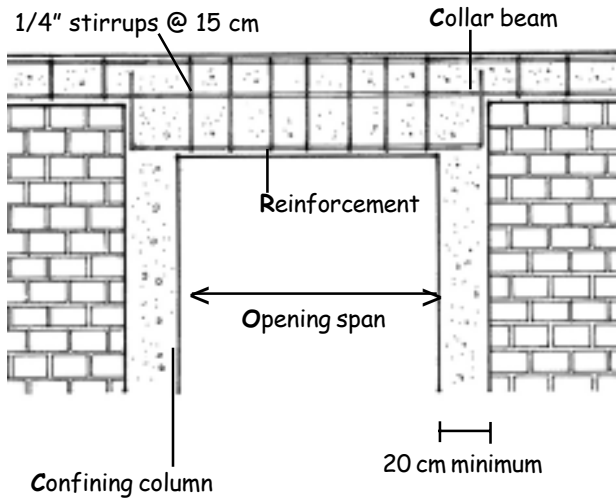

#### Additional reinforcement for lintel beams

Opening span	Reinforcement
0.80 m to 1.50 m	2 Ø 3/8 in.
1.50 m to 2 m	2 Ø 1/2 in.

#### Alternative 2

Beam with greater depth without confinement columns.

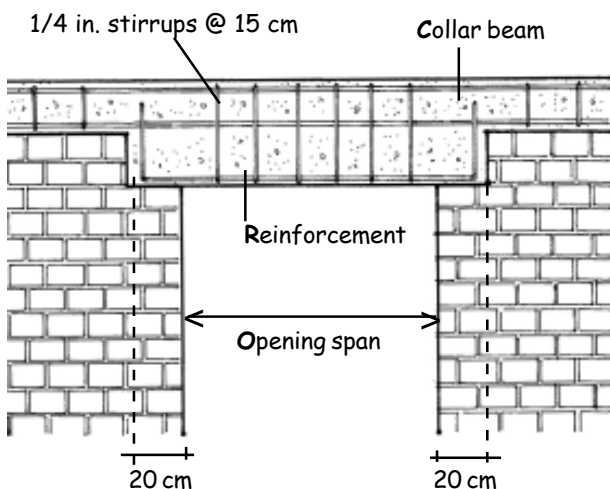

#### Alternative 3

Opening that goes up to the bottom of the collar beam.

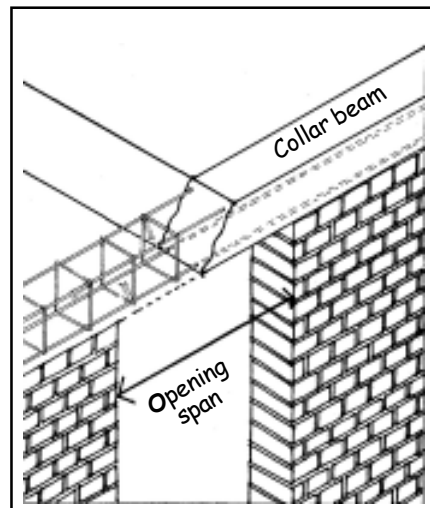

Minimum 25 cm



1/4 in. stirrups @ 15 cm

#### Standard collar-beam reinforcement

If the opening span is less than 1 m, you do not need to place additional reinforcement to the collar beam.

Minimum 25 cm



1 additional Ø 1/2 in.

#### Supplemental collar beam reinforcement

If the opening span is up to 1.5 m, add one additional 1/2 in. rebar to the lower reinforcement of the collar beam.

1/4 in. stirrups @ 15 cm

### Beam rebar assembly





Place the steel reinforcement bars of the collar beams on top of the walls after removing the formwork from the columns.

### Pouring of beams

All beams (collar, deep and flat) and lintels are poured simultaneously with the slabs.



**Concrete for beams and slabs**

	1 bucket of cement
	2 buckets of coarse sand
	4 buckets of crushed stone (maximum size 3/4 in.)
	1 bucket of water

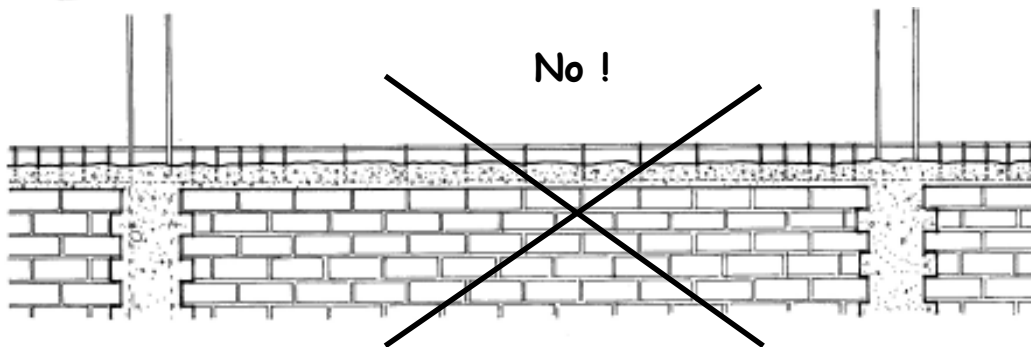

### Pipes/Plumbing in beams

**Never** bend beam rebars to pass drainage pipes.

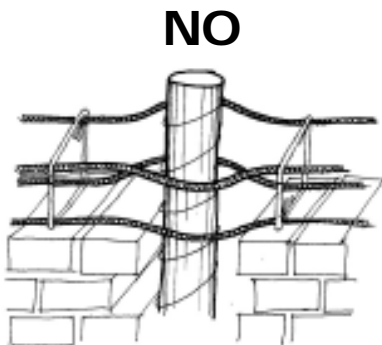

Bent rebars

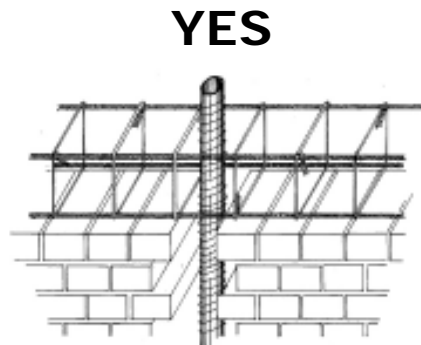

Straight rebars

9 • Lightweight slab

Slab components

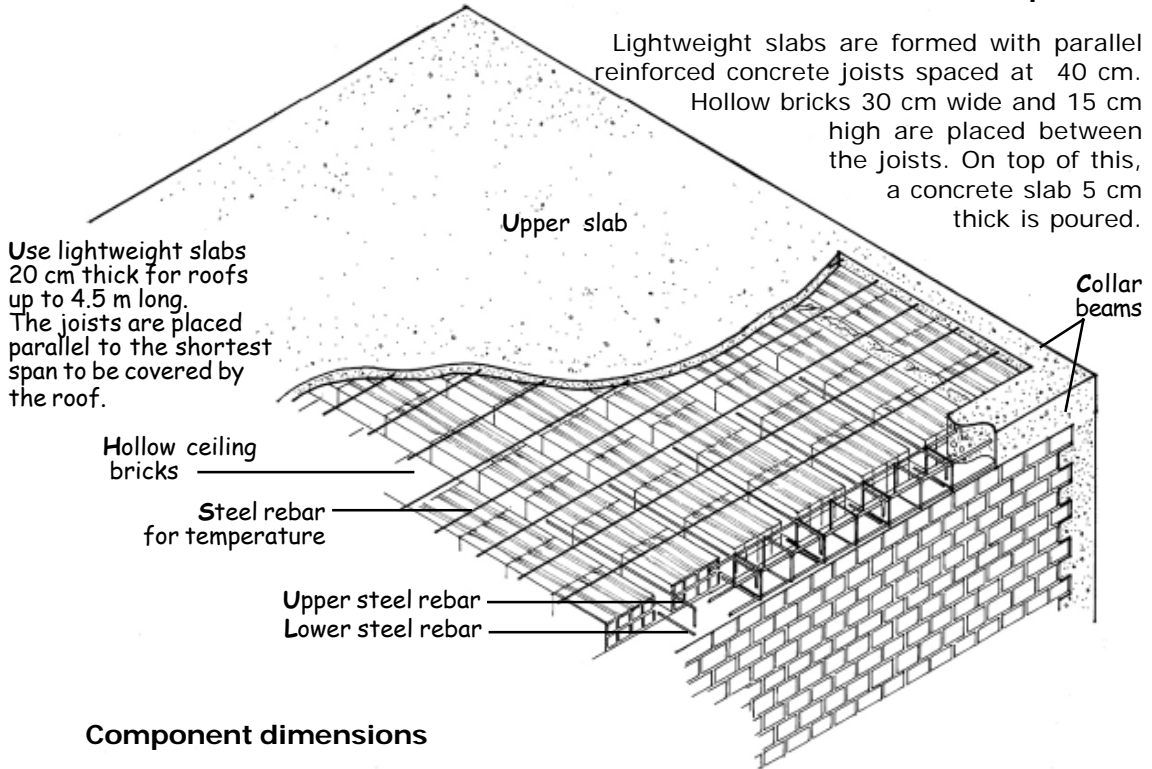

Component dimensions

The hollow ceiling bricks must be perfectly aligned and the slab has to be level.

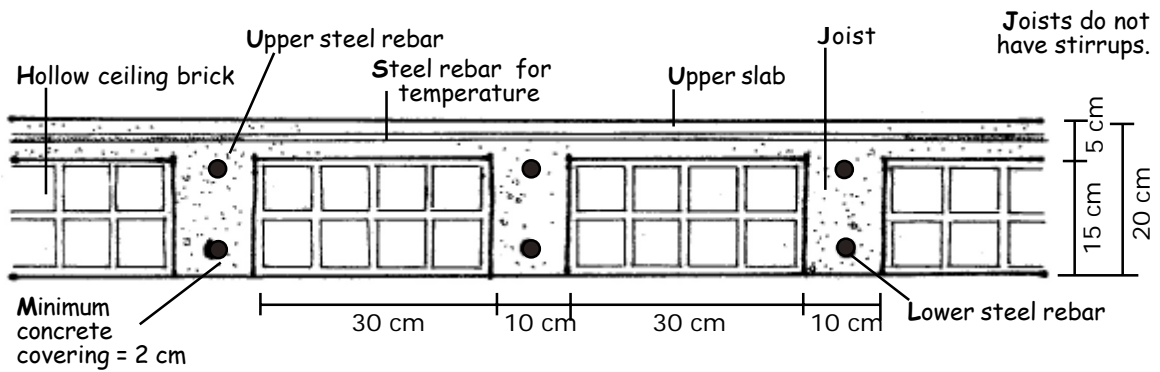

Temperature steel reinforcement

To prevent cracking of the upper slab due to temperature effects, you have to place 1/4 in. steel bars every 25 cm, perpendicular to the joists.

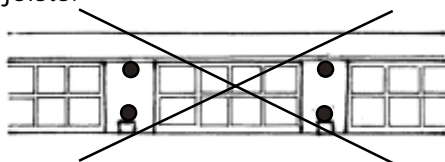

Temperature steel reinforcement is placed at mid height of the upper slab.

Prepare mortar cubes (2.5 cm per side) and use them as supports for joist reinforcement bars.

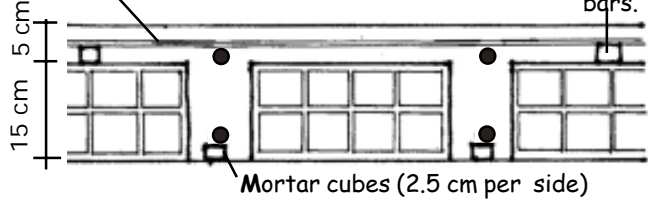

**NO!** Temperature steel reinforcement must not be in contact with the ceiling bricks.



**Slab formwork**

Prepare slab formwork with wooden boards at least 1 in. thick for each joist bed. Support the boards over 2 in. x 4 in. wooden beams which rest upon vertical wooden 2 in. x 3 in. posts.

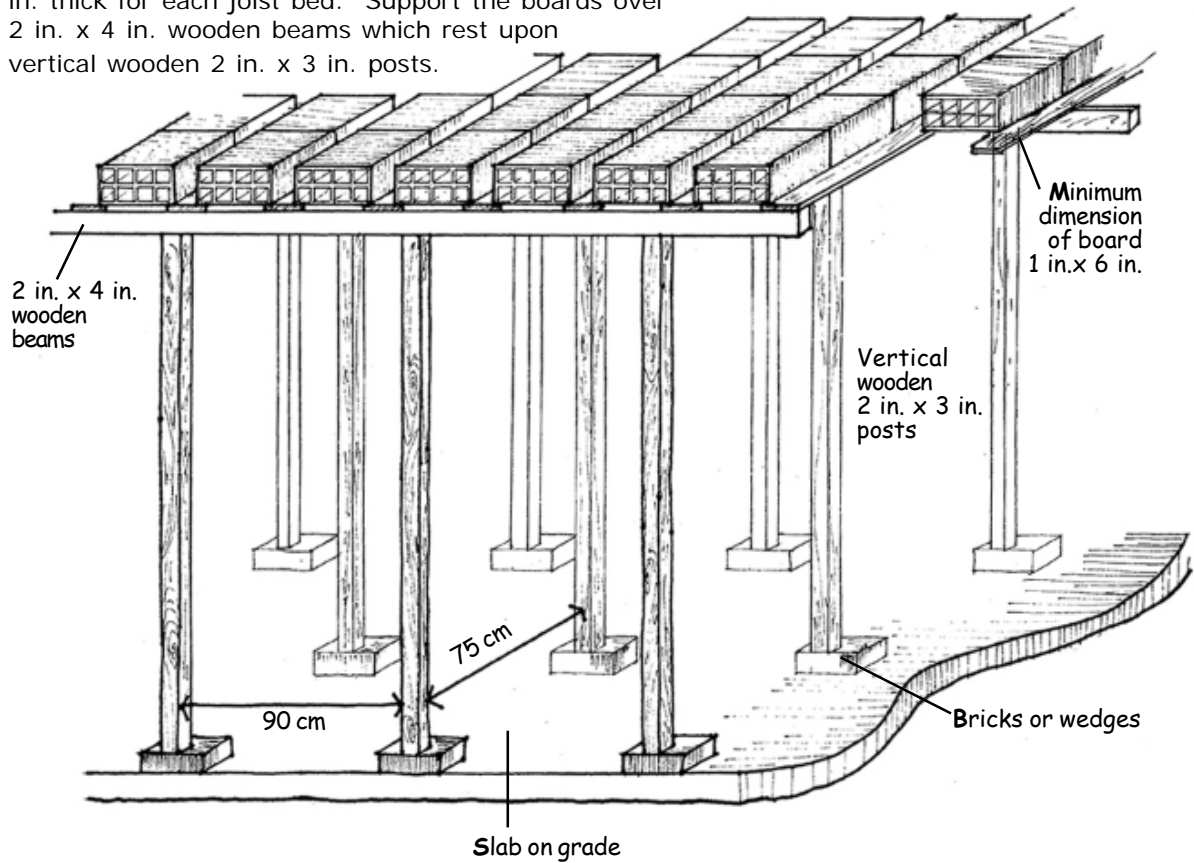

**NO**

**YES**

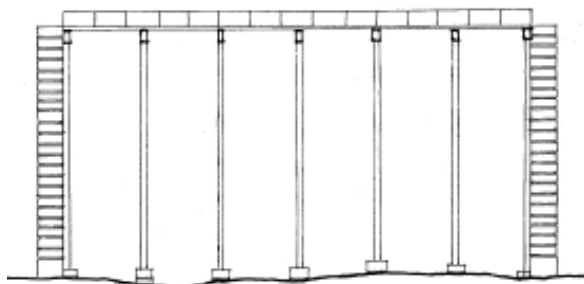

Never support lightweight slab formwork over non-compacted soil.

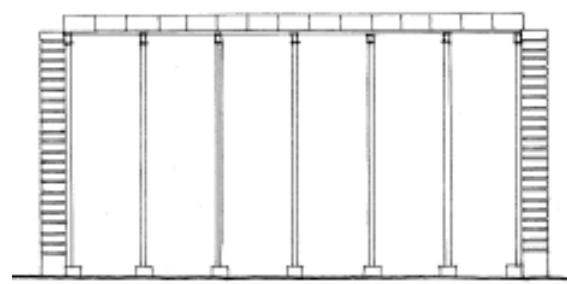

The slab on grade should be constructed before placing slab formwork. If there is no slab on grade, then the ground soil must be well compacted and leveled.

**Recommendation**

Never use inadequate materials such as cement bags, bricks or cardboard as formwork. If you do, concrete elements will be distorted.

**Connection between confining beam and joist rebar**

Tie joist upper reinforcement bar to confinement beam reinforcement with #16 wire.

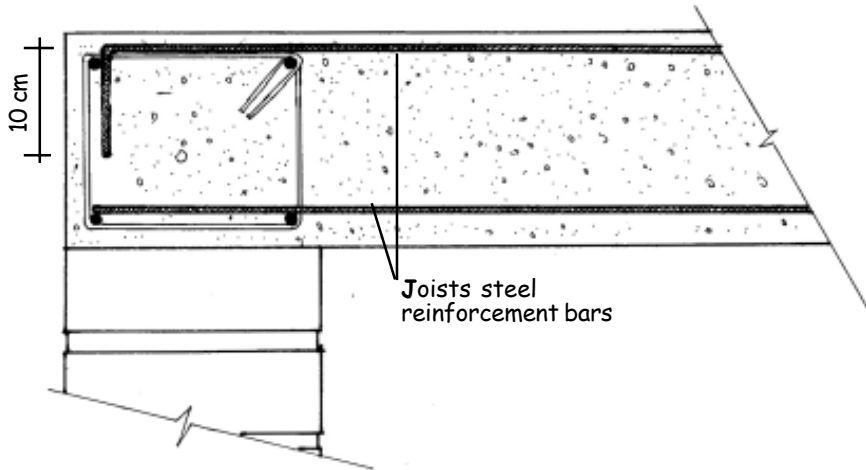

**Splices of joist rebars**

If you have to splice the lower reinforcement bars in a joist, do it in the extreme thirds of the free span.

Steel	Splice length
3/8 in.	40 cm
1/2 in.	50 cm

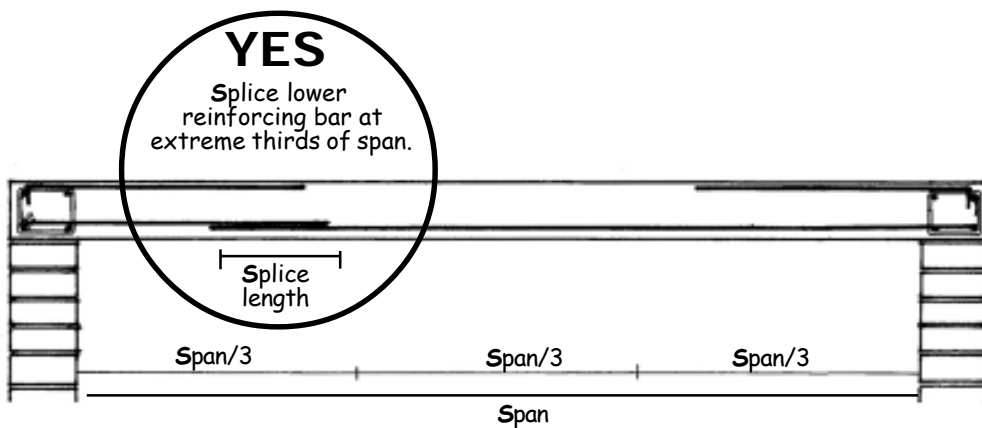
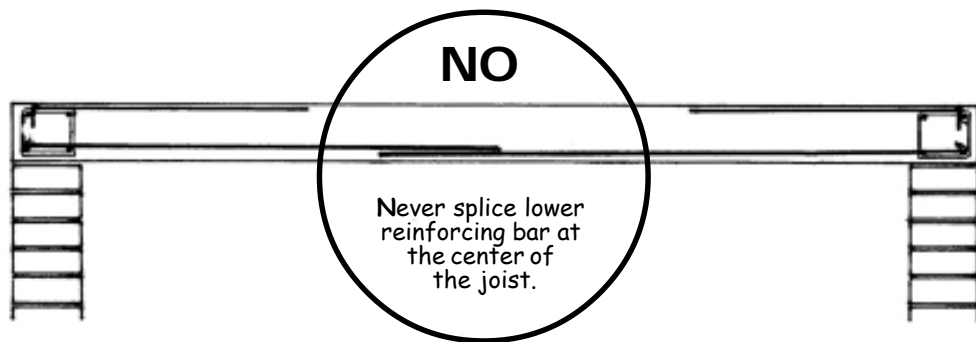

**Steel reinforcement necessary for each single span joist in a 20 cm lightweight slab system**

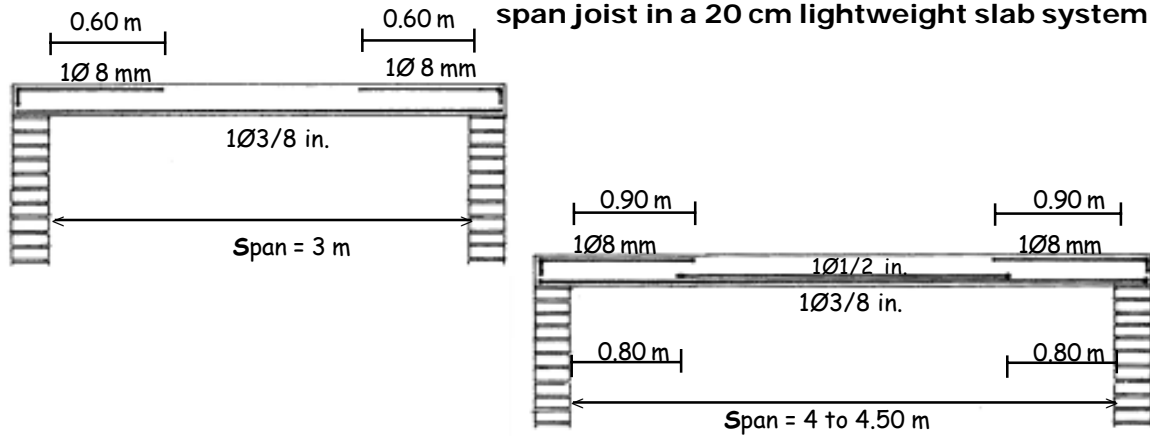

**Steel reinforcement necessary for each two span joist in a 20-cm lightweight slab system**

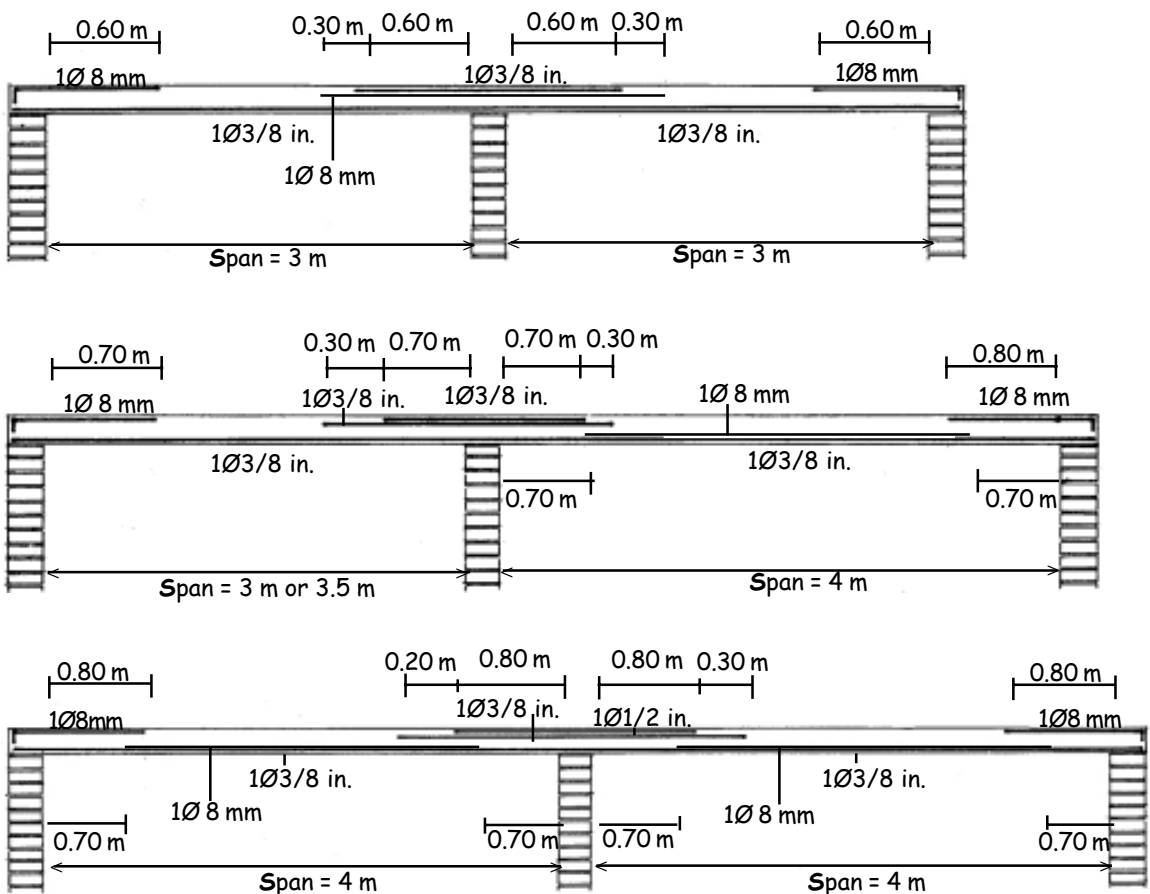

**Recommendations**

*If you have to build lightweight with long spans, consult an engineer. Lightweight slabs of great spans must be adequately designed to ensure their strength and safety.*

**Pipes in lightweight slab**

Water and drainage pipes must not cross lightweight slab joists. Pipe paths should be parallel to roof bricks alignment.

**NO**

**Incorrect piping location**

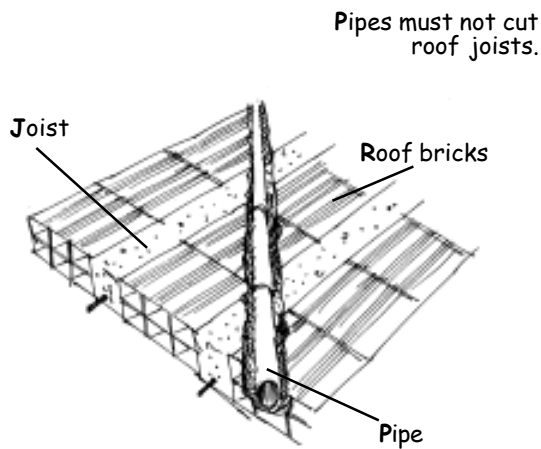

Do not place light centers in the joists.

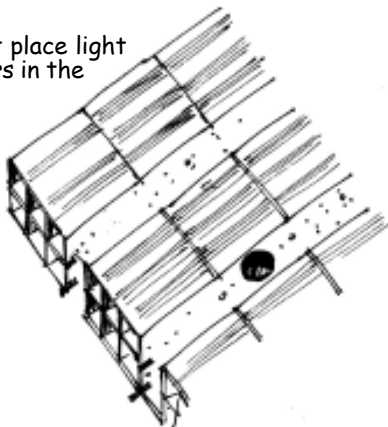

**YES**

**Correct piping location**

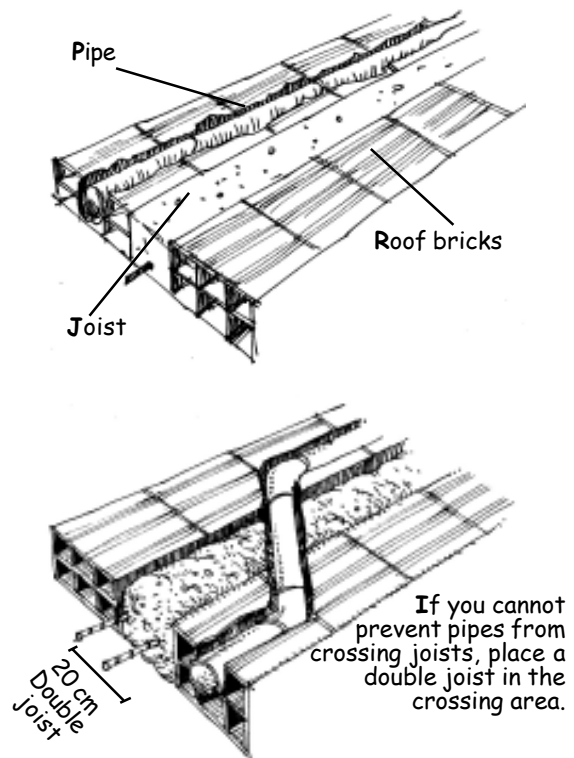

Place light centers in the roof bricks.

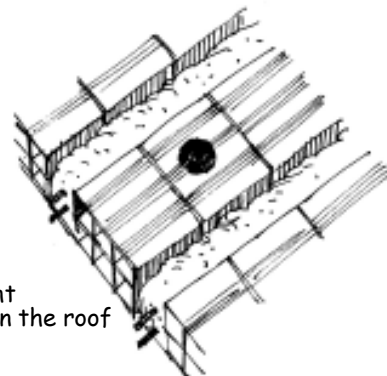

**Recomendation**

*Find out in your area which entities provide public water and drainage service as well as electric service and ask about the procedures you must follow so that your house can have connection to the public water and drainage system and access to an electrical connection.*

### Before pouring the slab

Before you pour the concrete slabs, verify that all water and drainage pipes do not leak.

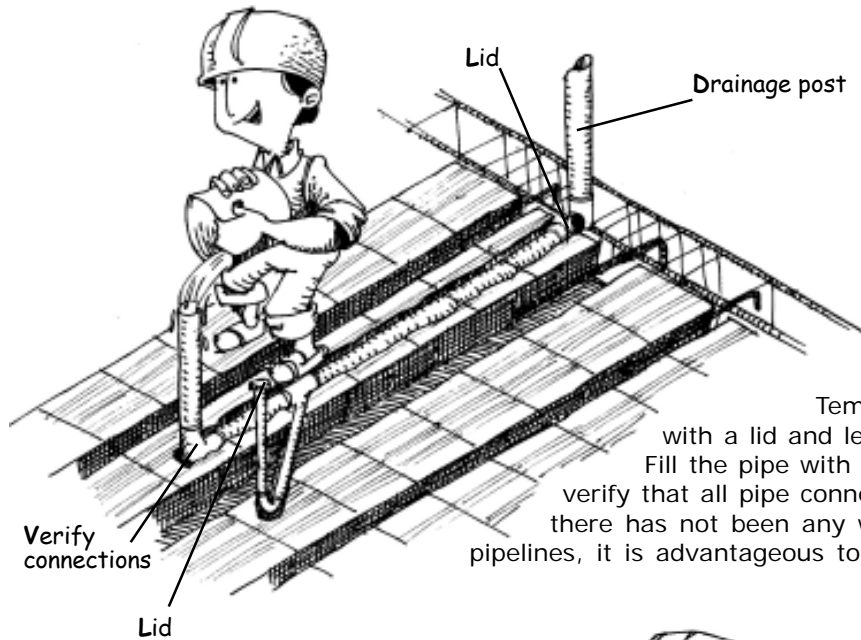

Temporarily block the pipes with a lid and leave open only one end. Fill the pipe with water and after 4 hours verify that all pipe connections are dry and that there has not been any water leakage. In water pipelines, it is advantageous to make this leakage test under pressure.

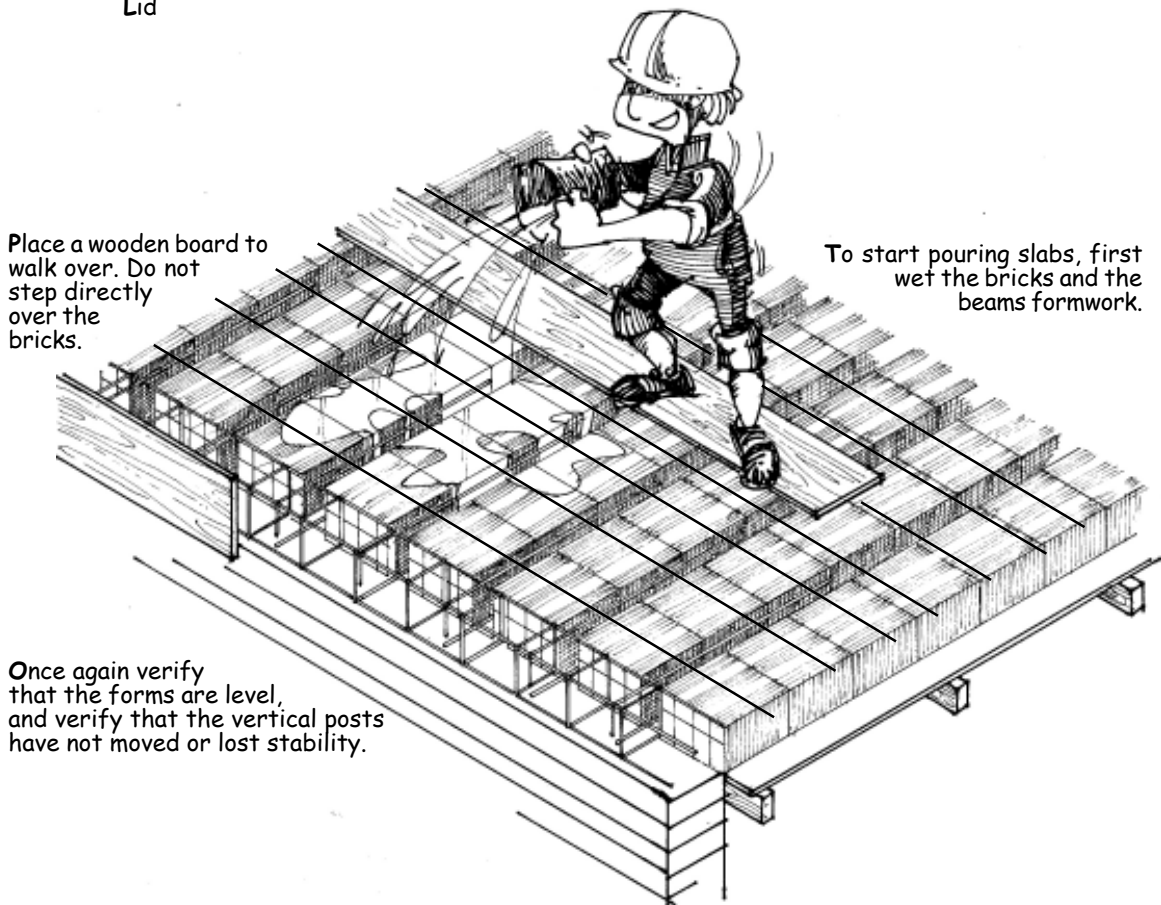

Once again verify that the forms are level, and verify that the vertical posts have not moved or lost stability.



### Pouring slabs and beams

Fill the lightweight slab and beams simultaneously because it is important that they work together. Start pouring collar beams, then joists and finally the upper slab. It is better you rent a mixer. This will help reduce the pouring time for your slab and save materials.

You must be very careful if you use a vibrator. The vibrator must be inside the concrete in a vertical position for a minimum of 3 seconds without touching the steel bars.

It is desirable to use a vibrator during pouring of slabs and beams. In case it is not possible, carefully use a rod to manually vibrate the concrete.

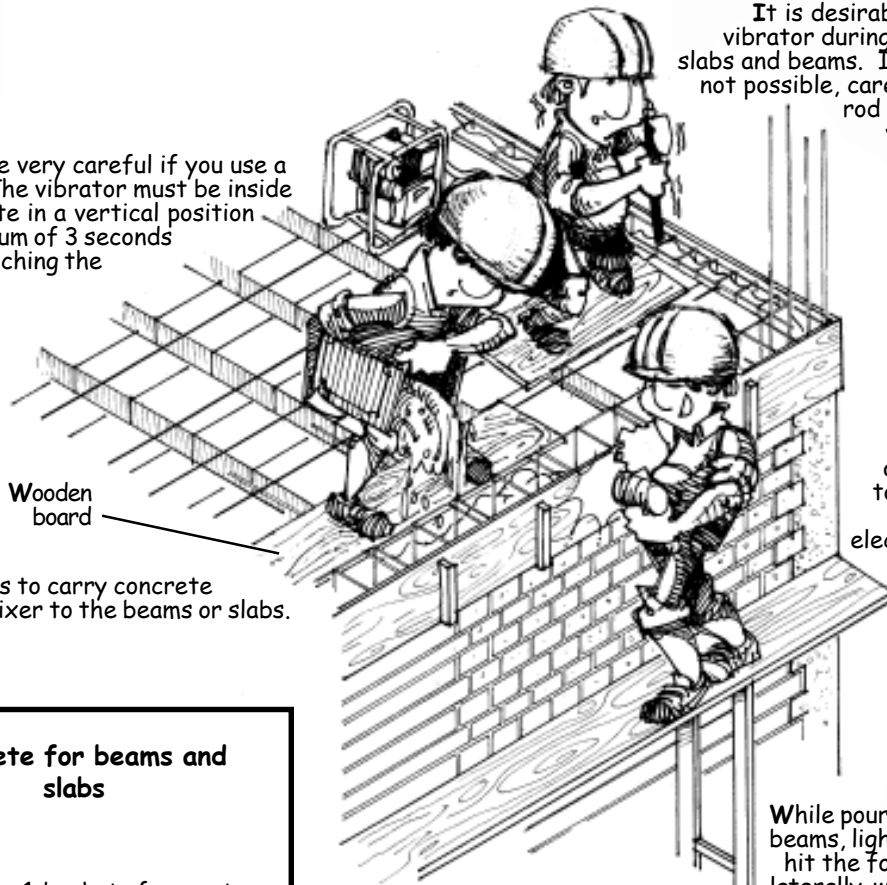

Wooden board

Use buckets to carry concrete from the mixer to the beams or slabs.

Pour the concrete carefully and try not to step over water or electric pipes.

#### Concrete for beams and slabs



1 bucket of cement



2 buckets of coarse sand



4 buckets of crushed stone (maximum size 3/4 in.)



1 bucket of water

While pouring beams, lightly hit the form laterally with a rubber hammer to prevent the formation of air pockets in the concrete.

#### Recommendation

Once the concrete slab is finished, the formwork must remain in place to support the slab for at least 14 days.

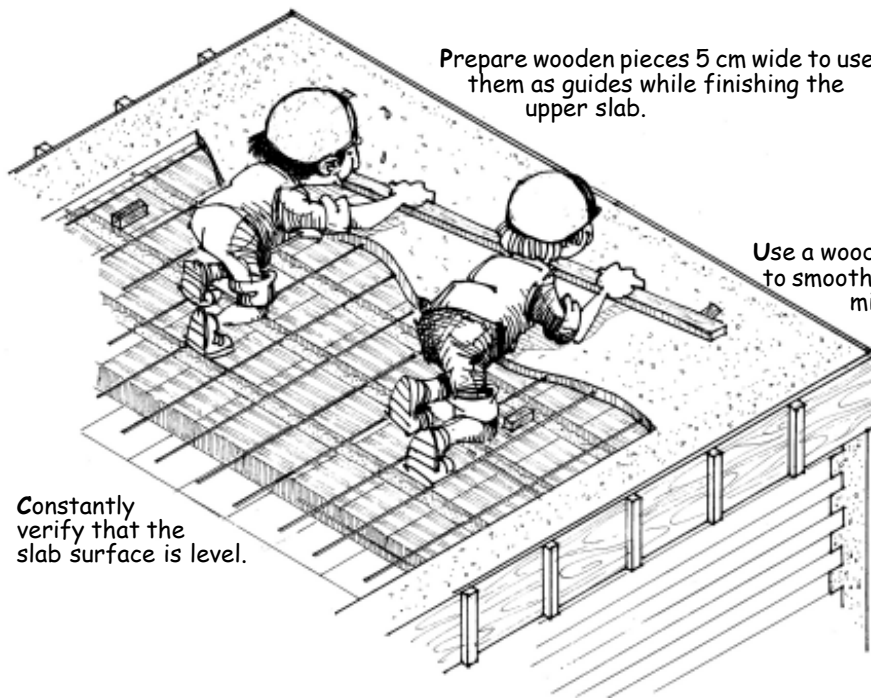

Prepare wooden pieces 5 cm wide to use them as guides while finishing the upper slab.

Use a wooden or metal straightedge to smooth and flatten the concrete mix. Once you have reached the desired level, remove the wooden guides and fill the holes with concrete.

Constantly verify that the slab surface is level.

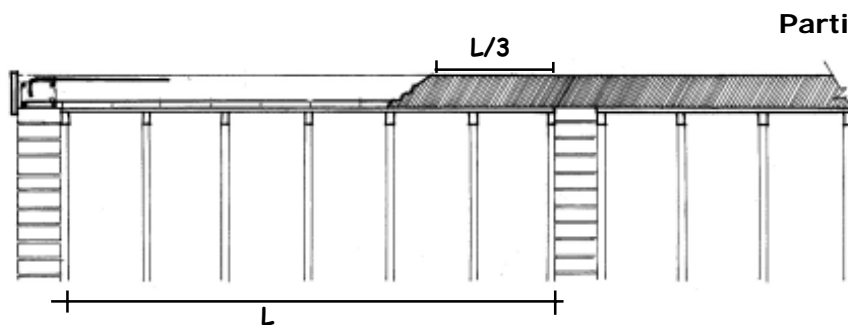

### Partial pouring of the slab

If you must stop pouring concrete in the slab, make the construction joint near the ends of the slab.

Never make the construction joint at the center of the slab.

### Curing the slab

The slab must be constantly cured. Curing must start as soon as possible. Do not wait until the next day to start. Form closed areas limited by sand piles over the slab and fill them with water. You must cure the slab for at least 7 days.

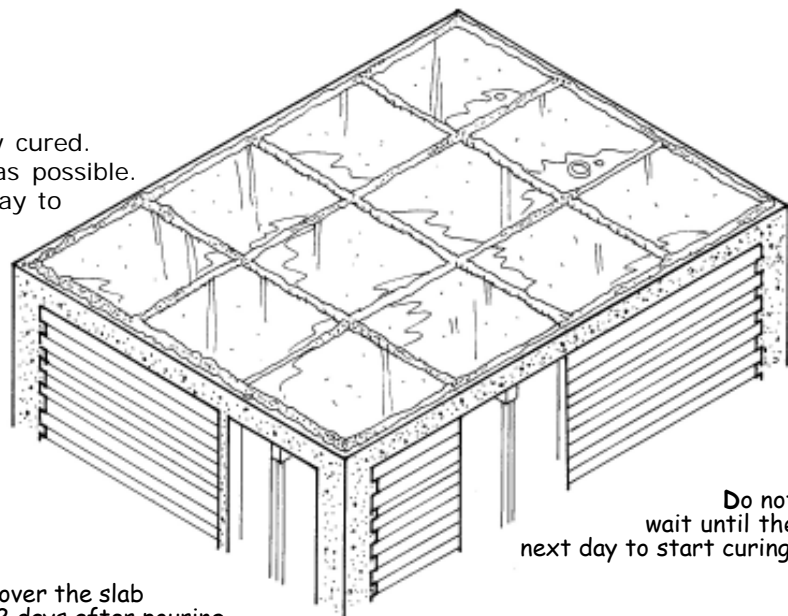

Do not wait until the next day to start curing.

Do not work over the slab for at least 2 days after pouring.

10 • Stairs

Typical detail of two-span stairs

First span

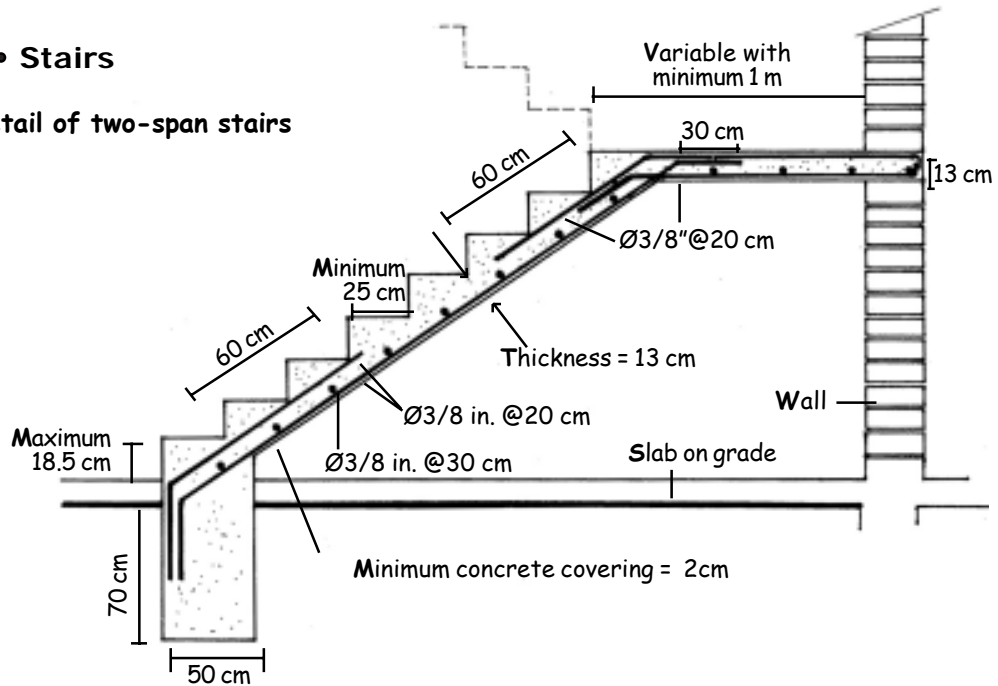

Second span

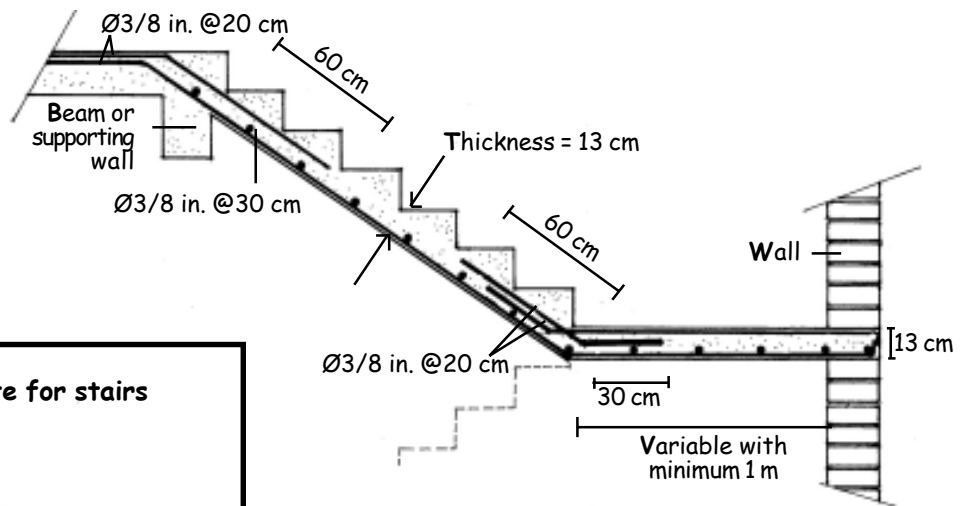

Concrete for stairs



1 bucket of cement



2 buckets of coarse sand



4 buckets of 3/4 in. crushed stone



1 bucket of water

5 cm long pipes

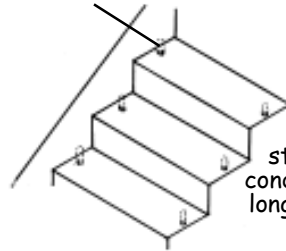

For installation of the stair handrail, leave 2 electrical conduits 1/2 in. diameter and 5 cm long in the formwork of each step.

**Recomendation**

When you pour stairs be careful to see that all reinforcing bars have adequate concrete cover.

This chapter contains recommendations for the maintenance and solution of some problems typical brick houses. If the problems or defects of your house are more serious, such as foundation settlement or severe cracking of walls or concrete elements, we suggest that you consult an engineer to solve them.

### 1 • Cracked walls

Cracks or fissures in walls may have several causes, such as use of poor-quality materials, inadequate constructive practices, deficient structure with too few confined walls in both directions or inadequate foundation over soft or loose soils. If your house has been poorly constructed and has some of these defects, it is possible that many of its elements will fail when an earthquake occurs.

#### Frequent cracks types in brick house walls

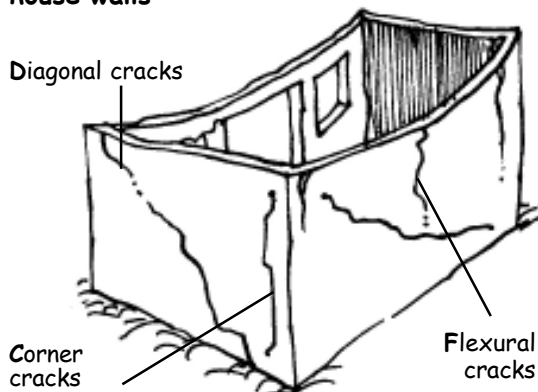

### Repair of wall cracks

If any wall of your house has diagonal cracks not more than 1.5 mm thick and the concrete of beams and columns is not severely damaged, you can repair the wall in the following way:

1

Remove mortar from cracked joints and eliminate all loose material. Try not to hit nearby bricks.

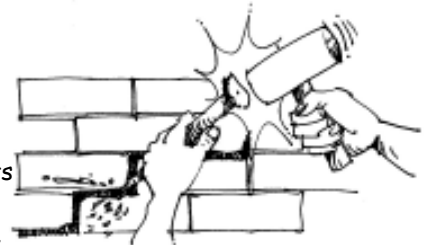

2

Clean cracked joints thoroughly with pressurized water. Let water drain during 15 minutes.

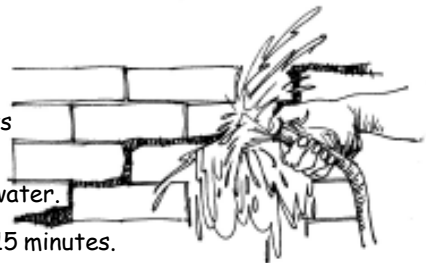

3

Refill the joint with new 1:4 (cement:sand) mortar. Apply and compact the mortar until you completely fill the joint.

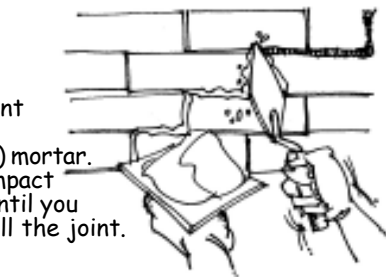

#### Recommendation

*If the walls of your house are severely cracked or have significant vertical cracks at the corners, it is possible that your house is in danger. Get professional assistance as soon as possible to solve the problem.*

### Replacement of deteriorated bricks

If any wall has broken or deteriorated bricks, you can replace them in the following way:

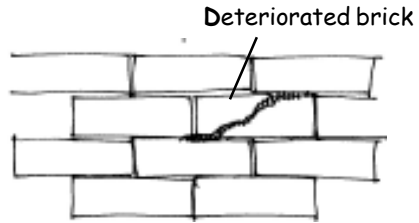

**1**

Carefully remove the damaged brick. Clean up the mortar that remains in the hole.

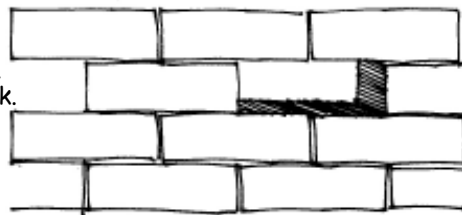

**2**

Get a new good quality brick to replace the removed brick.

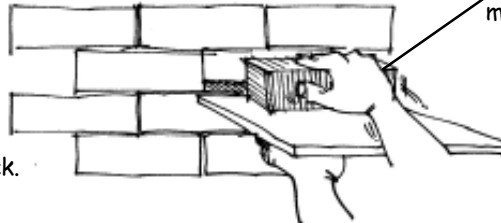

The new brick must be the same size as the damaged brick.

**3**



Thoroughly wet the bricks in the wall adjacent to the new brick and place new 1:4 (cement:sand) mortar along the edges of the hole. Carefully place the new brick. To finish, fill any remaining spaces around the new brick with mortar.

#### **Recommendations**

If you need to replace more than one deteriorated brick, start with the lowest brick.

You can cut the new bricks so that they fit better in the openings left by the damaged bricks.



## 2 • Corrosion of reinforcing steel

When concrete covering is too thin or has air pockets and fissures through which moisture penetrates, corrosion of the steel reinforcement is produced. You can prevent this problem if you carefully construct the beams and columns of your house.

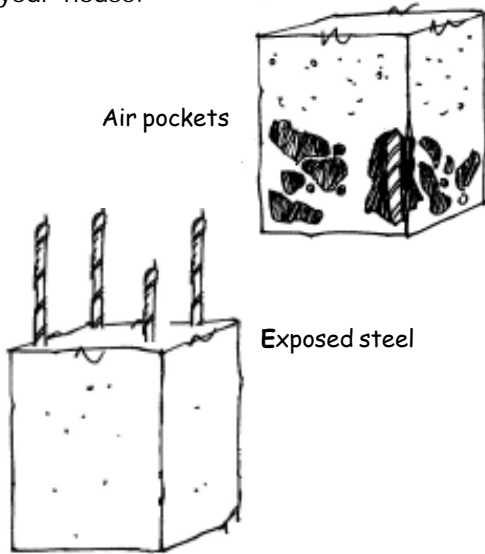

If beam and column steel reinforcement in your house is not too corroded, you can repair the problem the following way:

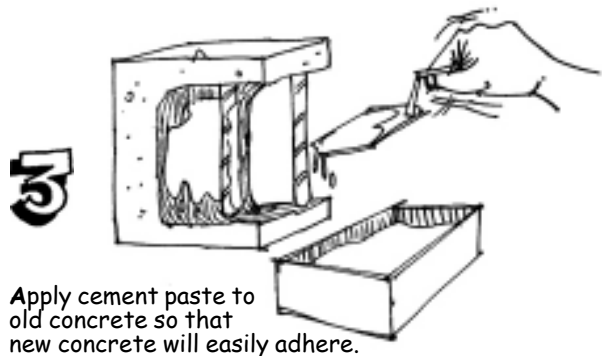
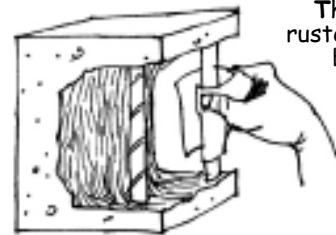
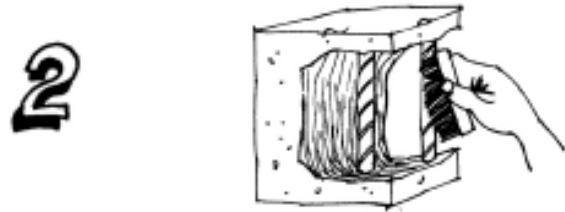

### 3 • Efflorescence

Efflorescence is a white or yellowish deposit that appears in brick or concrete walls. Efflorescence appears when construction materials or foundation soils contains salts that are dissolved in water. Water raises through the wall until it reaches the surface and then evaporates, leaving salts crystals at the wall surface as stains.

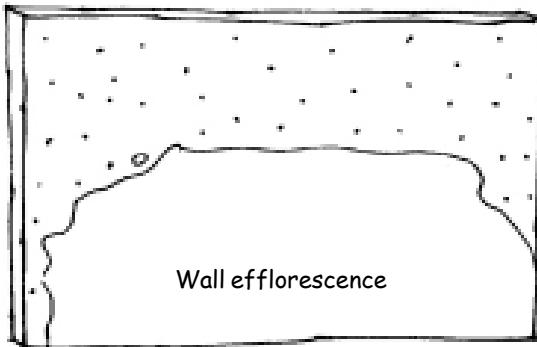

Moderate efflorescence does not affect wall strength.

To clean walls with moderate efflorescence you can do the following:

**1**



Clean the affected area with abundant water and a strong brush.

**2**

Prepare a cleaning solution with one volume of hydrochloric acid and 20 volumes of water. Apply the solution to the wall with a paintbrush and let it stand for 15 minutes.



Never put more hydrochloric acid because it is extremely corrosive.

**3**

Rinse the wall surface with abundant water.

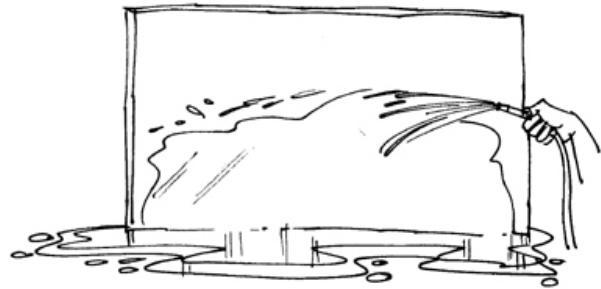

If your ground soil or your wall are damp or are subject to moisture intrusion, it is possible that efflorescence will reappear.

**Recomendation**

Try to prevent moisture penetration into the walls of your house so that efflorescence will not appear again.

#### 4 • Wall moisture

Damp walls are almost always caused by leaking water pipes. To repair water leakages and thus prevent moisture accumulation in your walls, you can do the following:



1 Break the wettest surface of the wall until you find the leaking pipe.

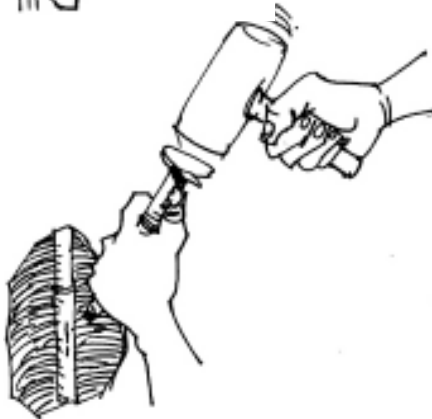

2



2 Thoroughly clean the pipe and locate the place where it is leaking. A broken pipe or a defective connection between pipes or accessories can cause leaking.

3

3 Shut off the main water valve to your house so that water does not pass through the damaged pipe.

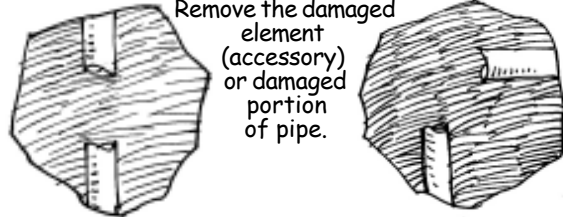

Remove the damaged element (accessory) or damaged portion of pipe.

4

4 Replace the damaged elements with new ones. Let the new connections dry completely. Wait a couple of days to verify that there are no more leakages.

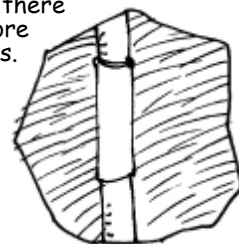
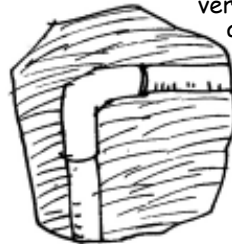

5

5 Patch the wall with mortar (cement:sand) 1:5.



### 1 • Why are drawings useful?

Before you start construction you must have drawings which show the appearance of your house to be and how you will build it. **Architectural drawings** are scaled representations of how your house will look, how many rooms it has and how they are located. **Structural drawings** indicate the locations and dimensions of the bearing walls, slabs roof reinforcement and dimensions and steel reinforcement of beams and columns. Finally, **mechanical, electrical and plumbing drawings** show the route of water and sewage pipes and of electric conduits.

#### Drawings are useful because:

- ✓ They help you determine if your house will satisfy your present and future family requirements.
- ✓ They permit you evaluate precisely the cost of materials necessary for construction.
- ✓ They enable you to program construction stages of the house according to your economic resources.
- ✓ They enable you to program accurately the construction of each stage, eliminating improvisation. This way later you will not regret a poor design that will cause demolition or alteration of walls or require changing the position of doors.

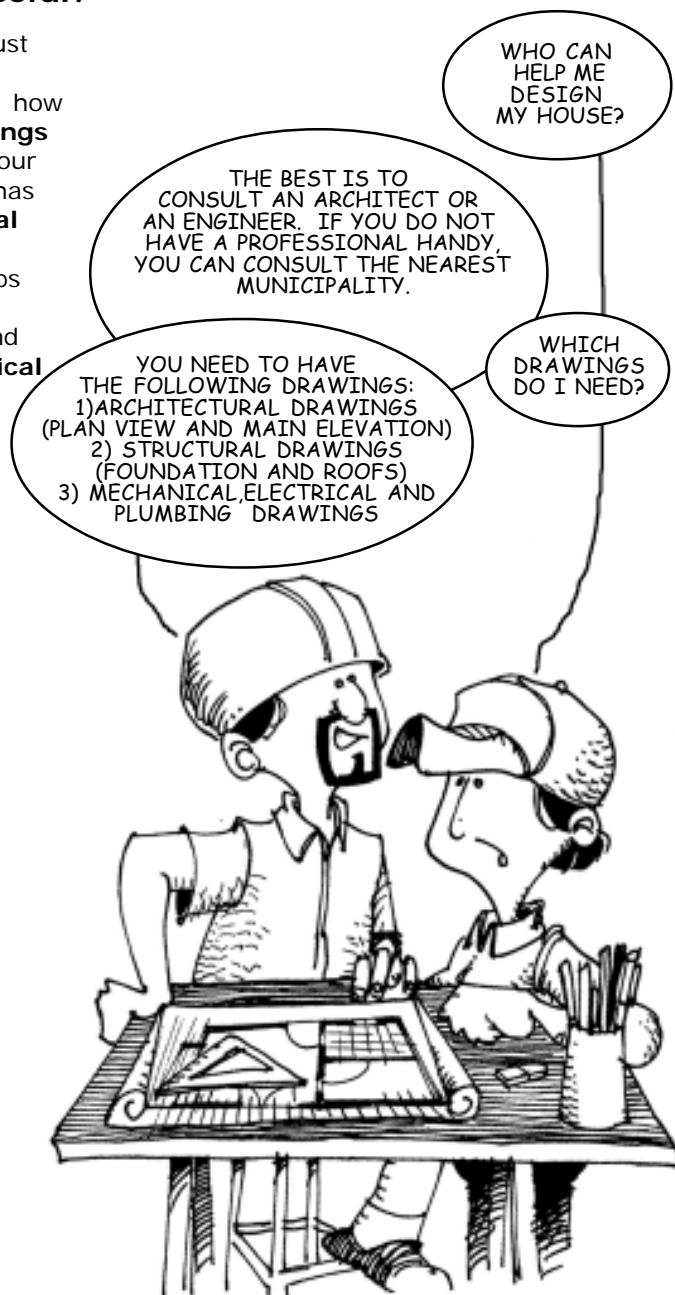

## 2 • The design of your house

A well-designed house has the following characteristics:

- ✓ It is earthquake-resistant. To achieve this it must have a sufficient quantity of confined walls in both directions (See Chapter 2 and Appendix).
- ✓ It responds to your family's present and future needs.
- ✓ It is easily constructed in stages.
- ✓ All rooms have natural illumination and ventilation.
- ✓ Bedrooms are well located, far from the noisiest areas, such as kitchen, dining and living rooms.
- ✓ It has a patio or laundry.
- ✓ It has a garden where you and your family can grow flowers, trees or vegetables.



Kitchens and bathrooms with natural illumination and ventilation.

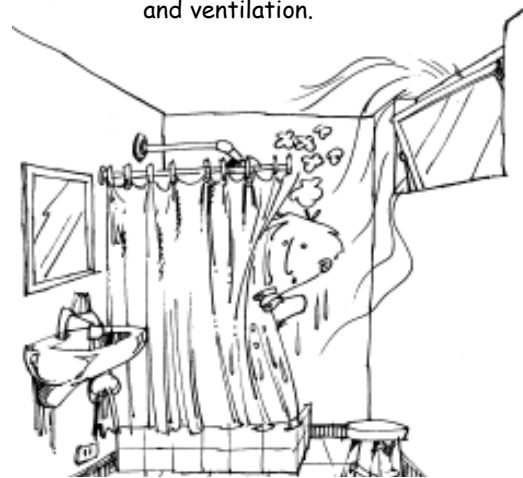

Houses with gardens.

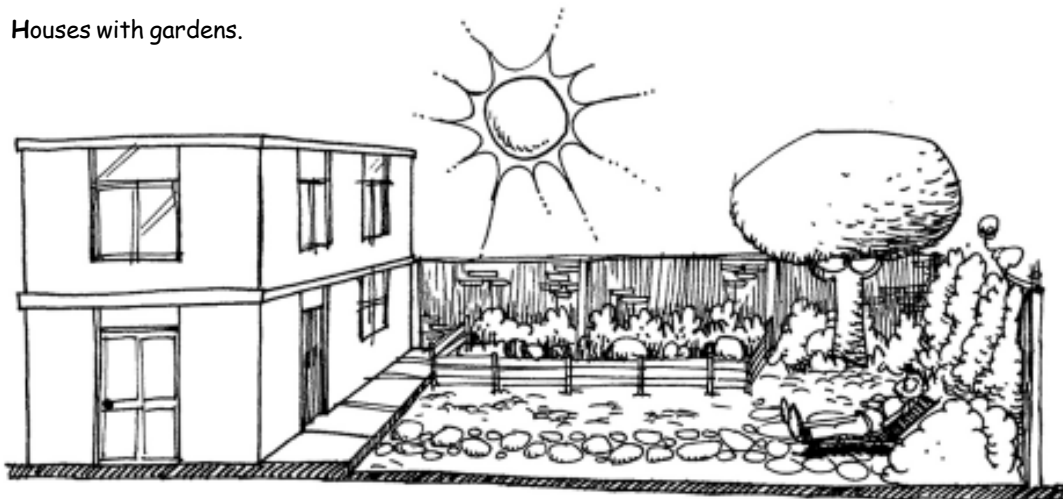



3 • Sample house plans

Sample Plan 1: Corner house

Here is a two-story house plan for a 8m x 8m ground corner property.

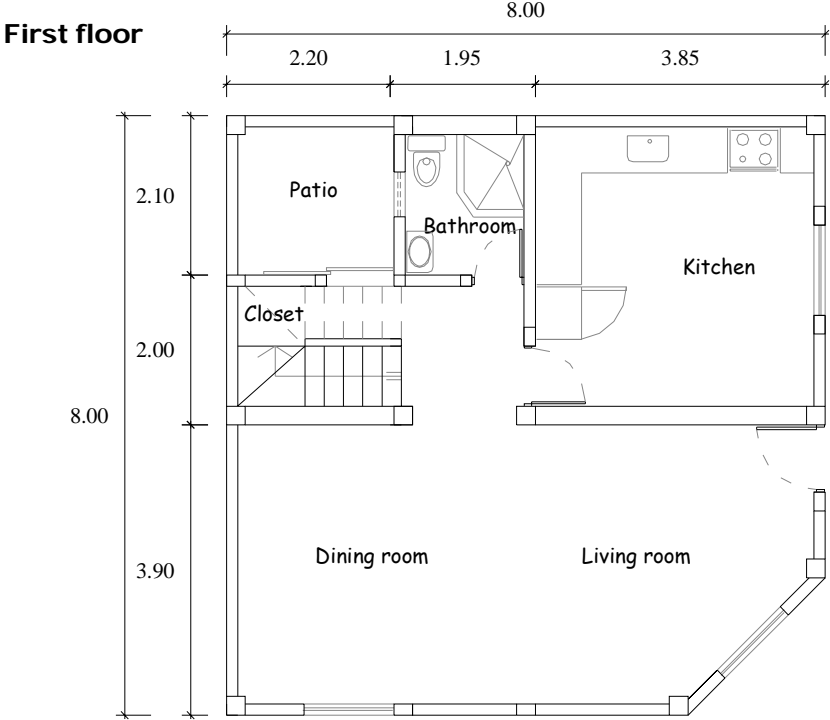

**Second floor**

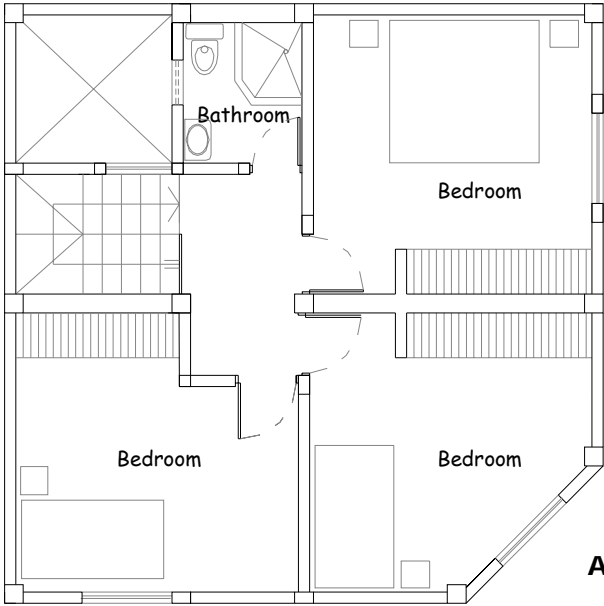

Architectural drawings  
Scale 1:100

**Sample plan 2: House between party walls**

This is a two-story house plan for a 8m x 20 m ground property between party walls. In this house it is possible to use one of the first-floor rooms as workshop or store (if your area zoning allows for it).

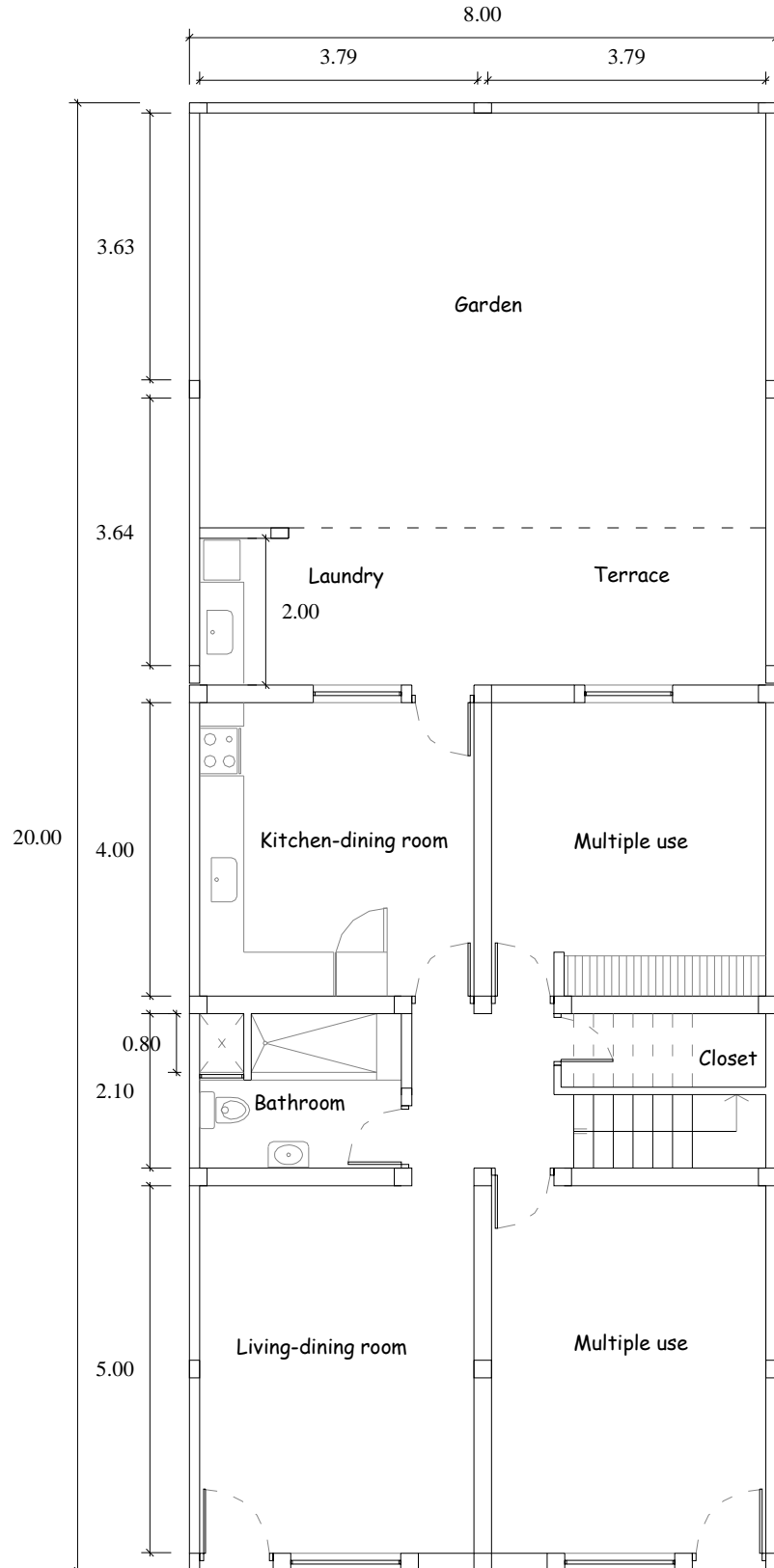

**Architectural drawing**  
 First floor  
 Scale 1:100

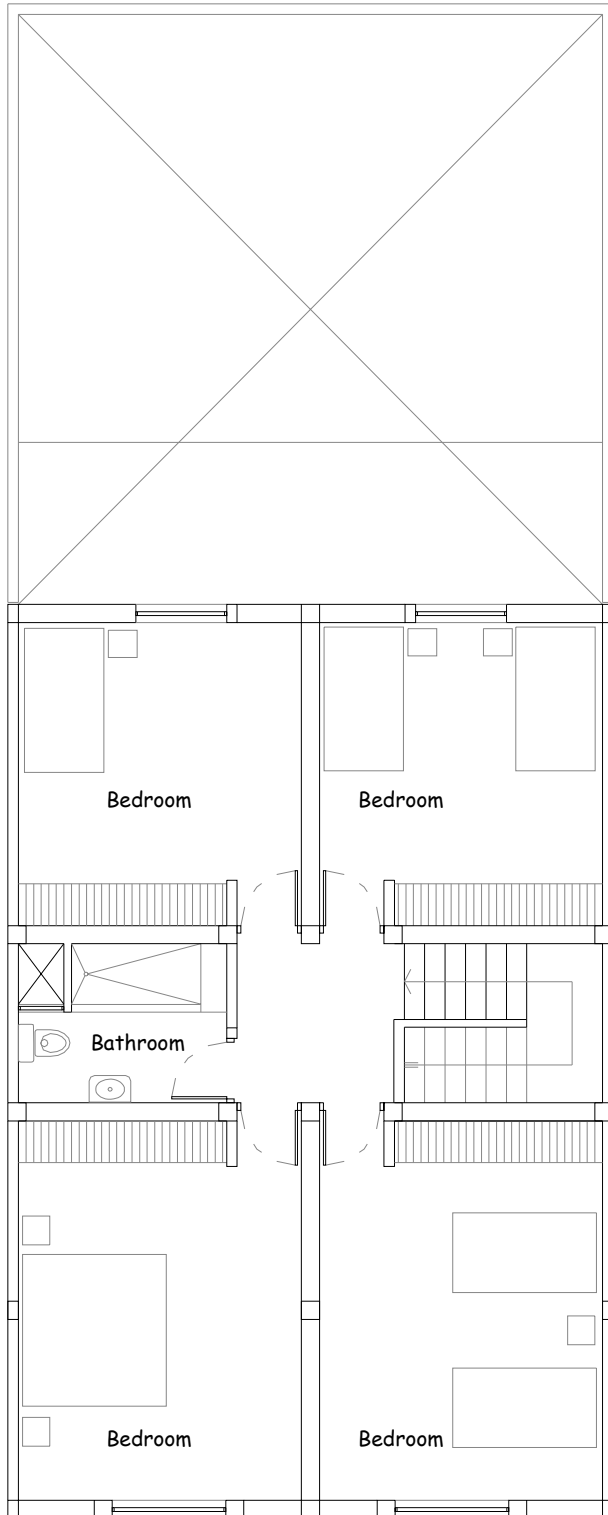

**Architectural drawing**  
Second floor  
Scale 1:100

### Sample plan 3: House between party walls

Here is a two story house plan where a different family can live on each floor. This house has all the drawings necessary to build it over hard soil (rock or gravel). Remember it has been designed to have only two floors.

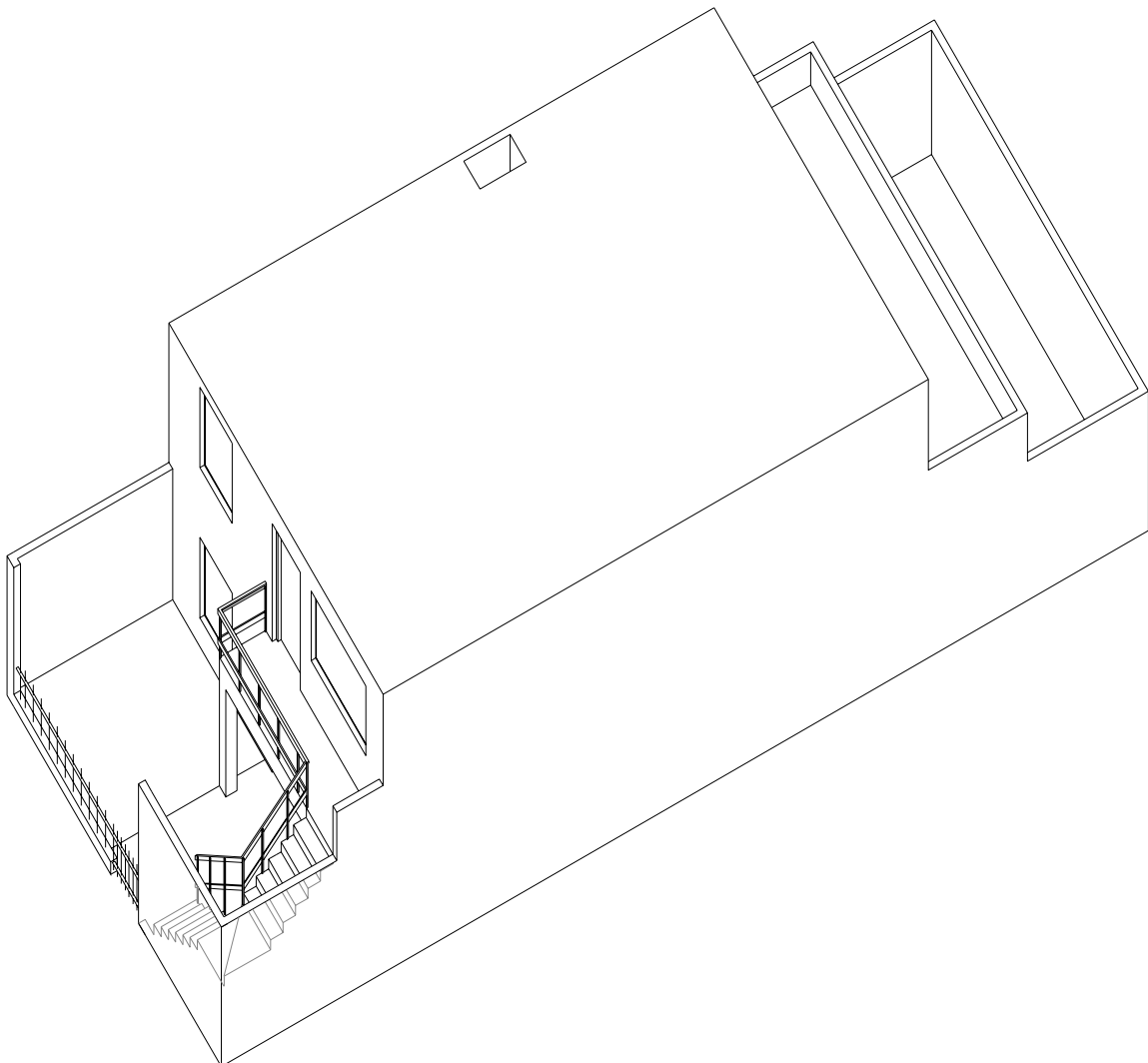

**Main elevation**



**Section A-A**

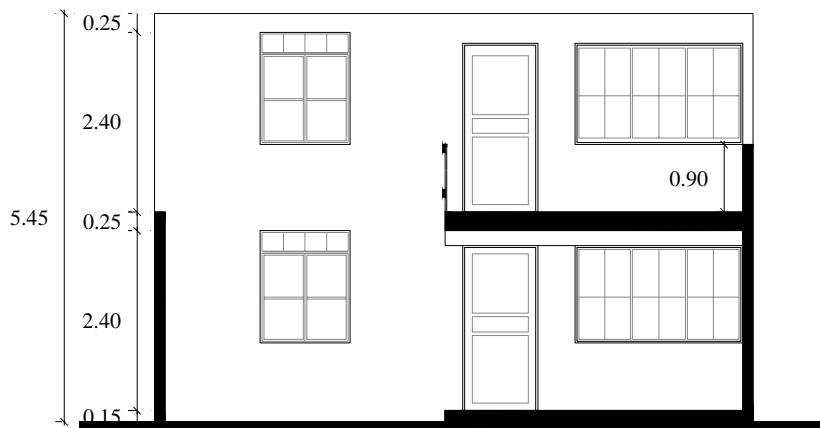

Opening schedule			
	Width	Height	Sill height
D-1	1.00	2.20	0
D-2	0.80	2.40	0
D-3	0.70	2.40	0
D-4	1.00	2.40	0
D-5	1.00	2.40	0
W-1	2.00	1.30	0.90
W-2	1.20	1.30	0.90
W-3	0.60	0.60	1.00

**Rear elevation**



**Section Elevations**  
Scale 1:100



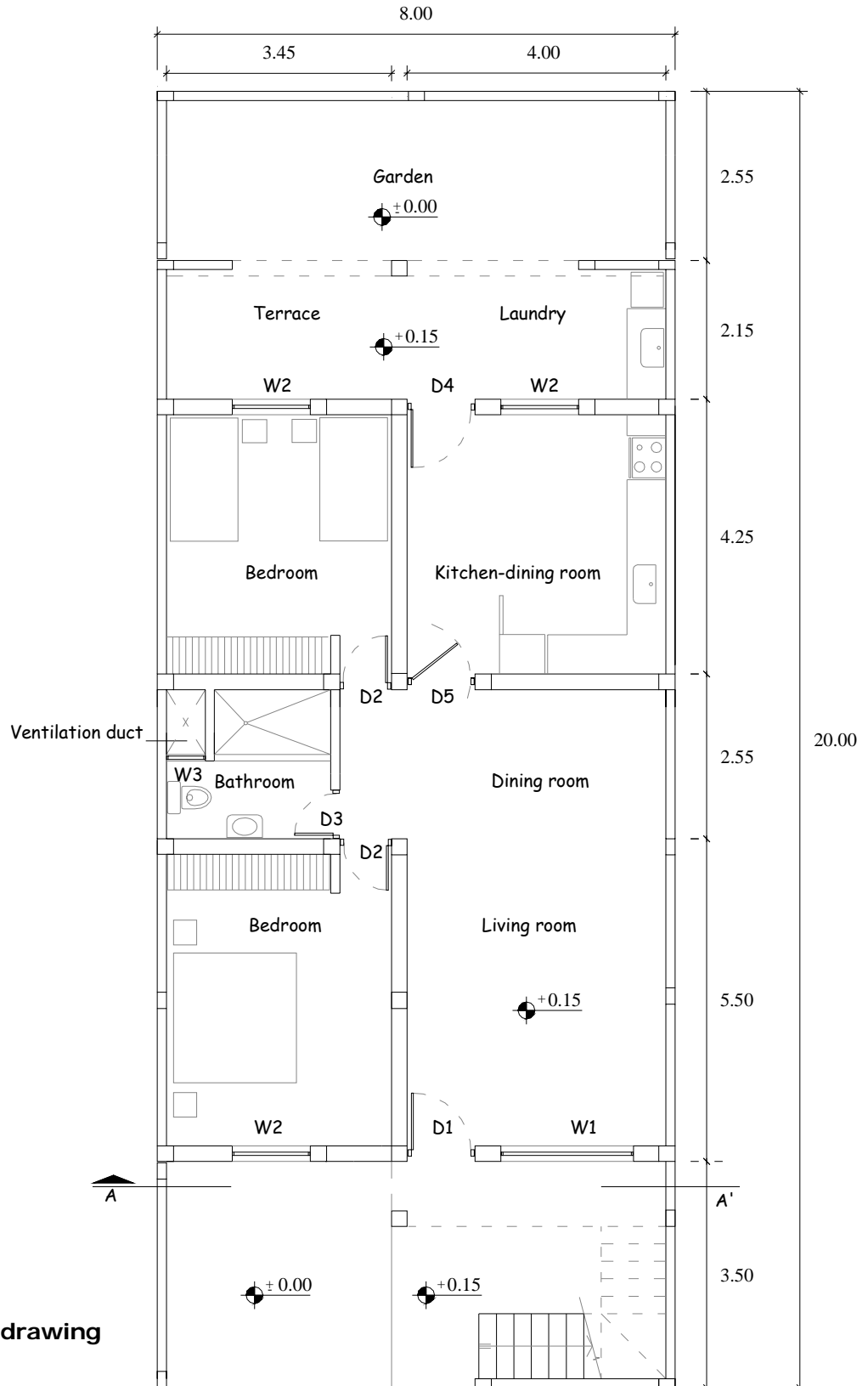

**Architectural drawing**  
 First floor  
 Scale 1:100

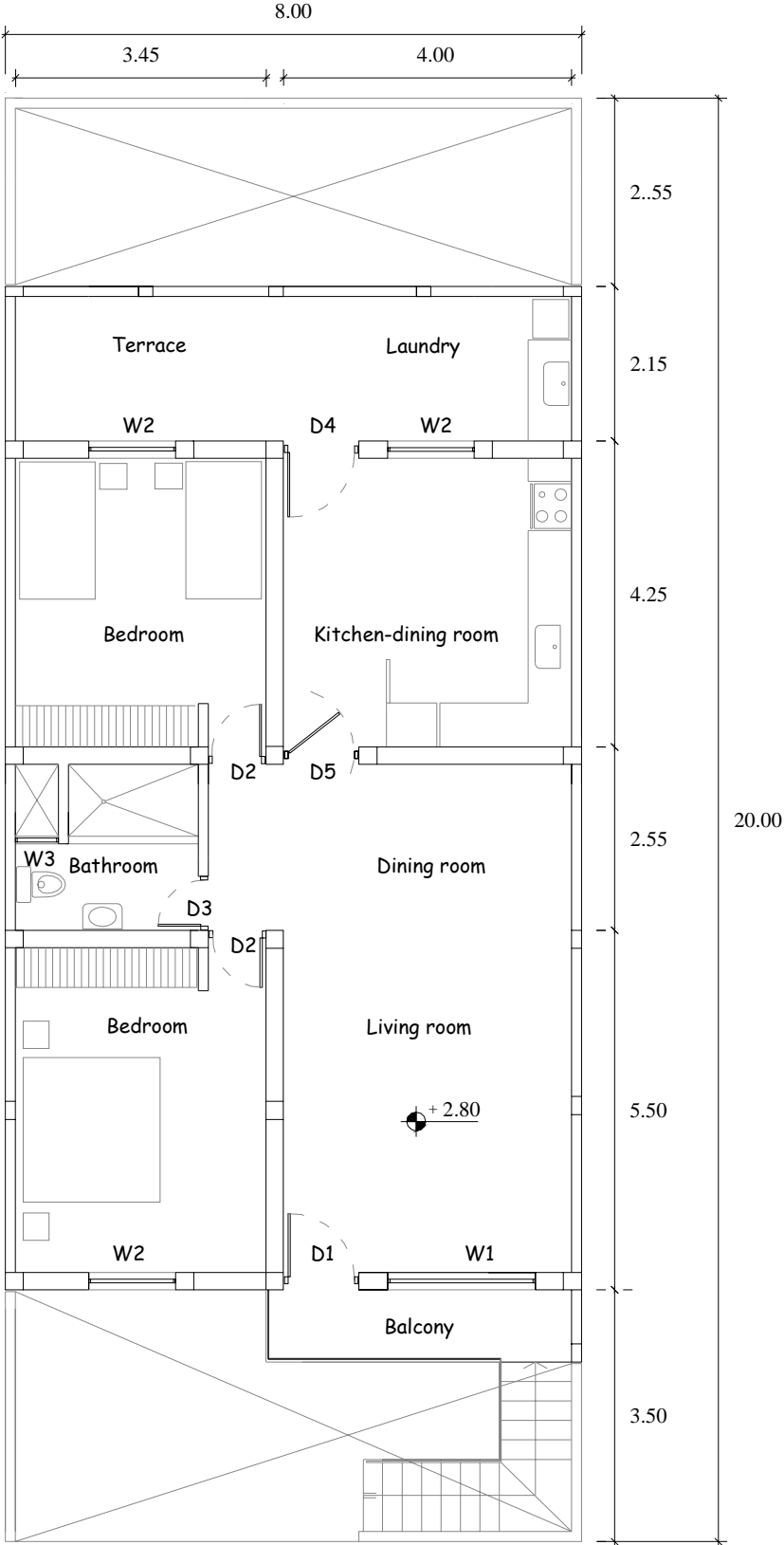

**Architectural drawing**  
Second floor  
Scale 1:100

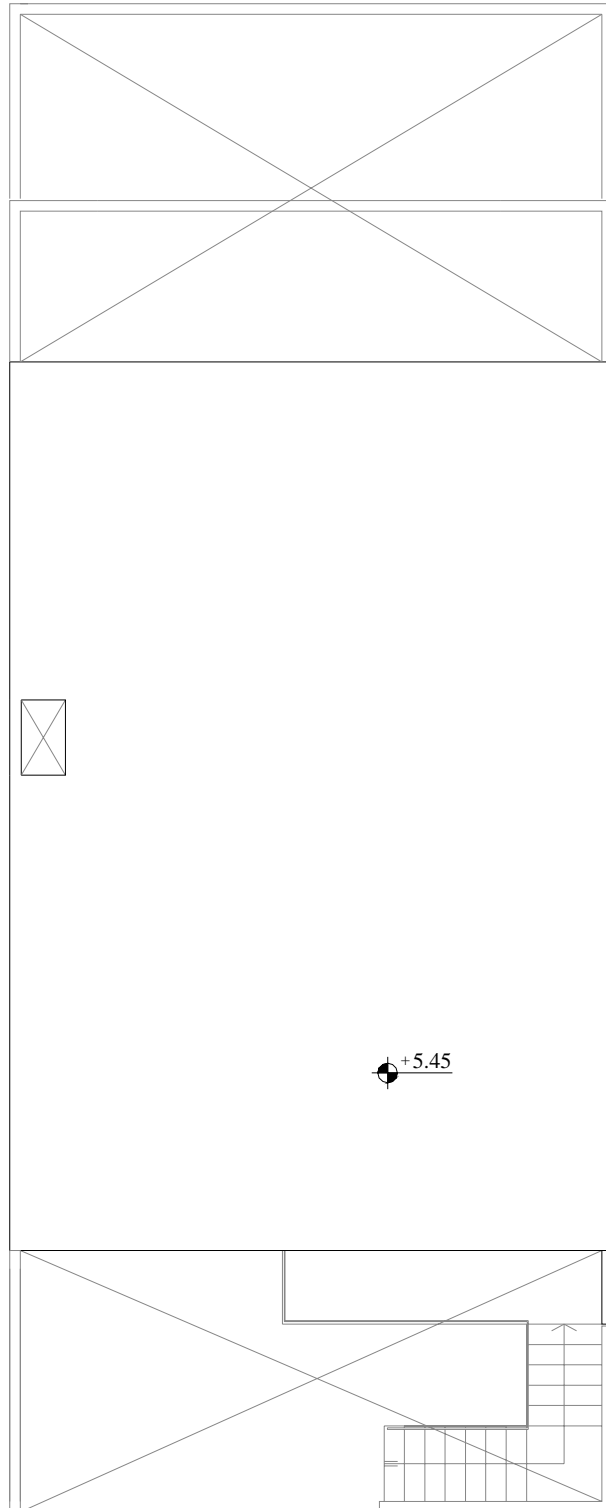

**Architectural drawing**  
Roof floor  
Scale 1:100

### Construction by stages

You can build this house in several stages. For example, you could build the house in 5 stages according to this sequence:

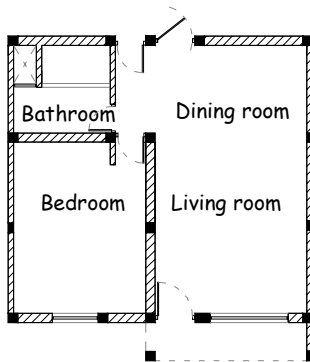

First stage

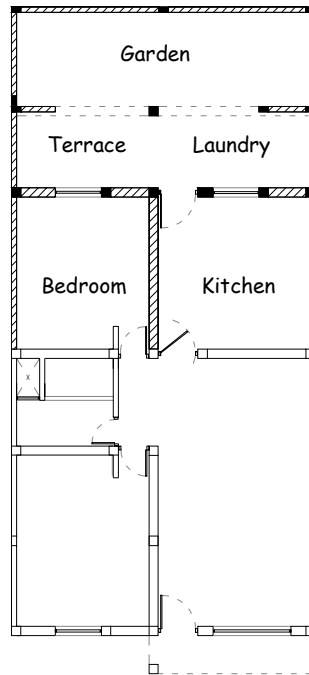

Second stage

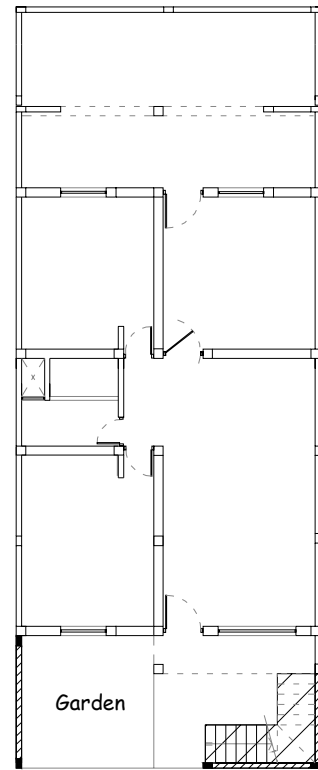

Third stage

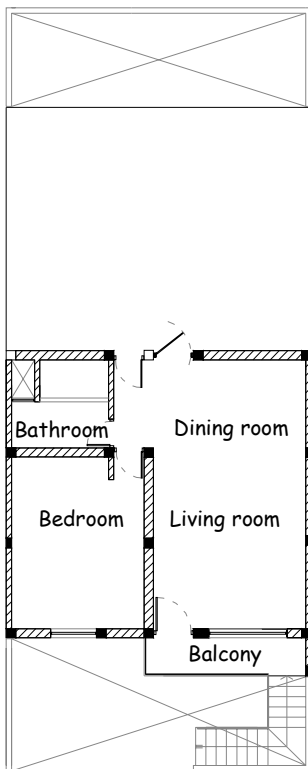

Fourth stage

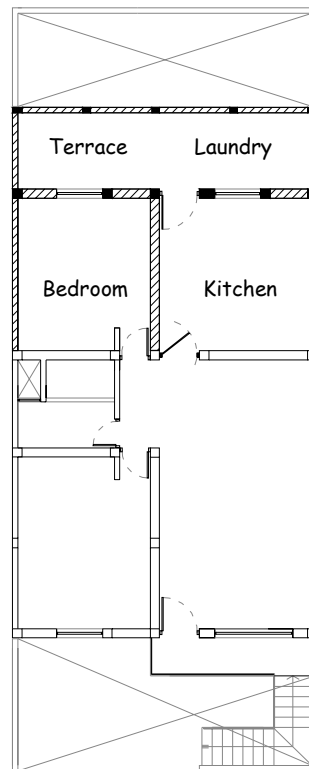

Fifth stage

Architectural drawing  
Scale 1:200

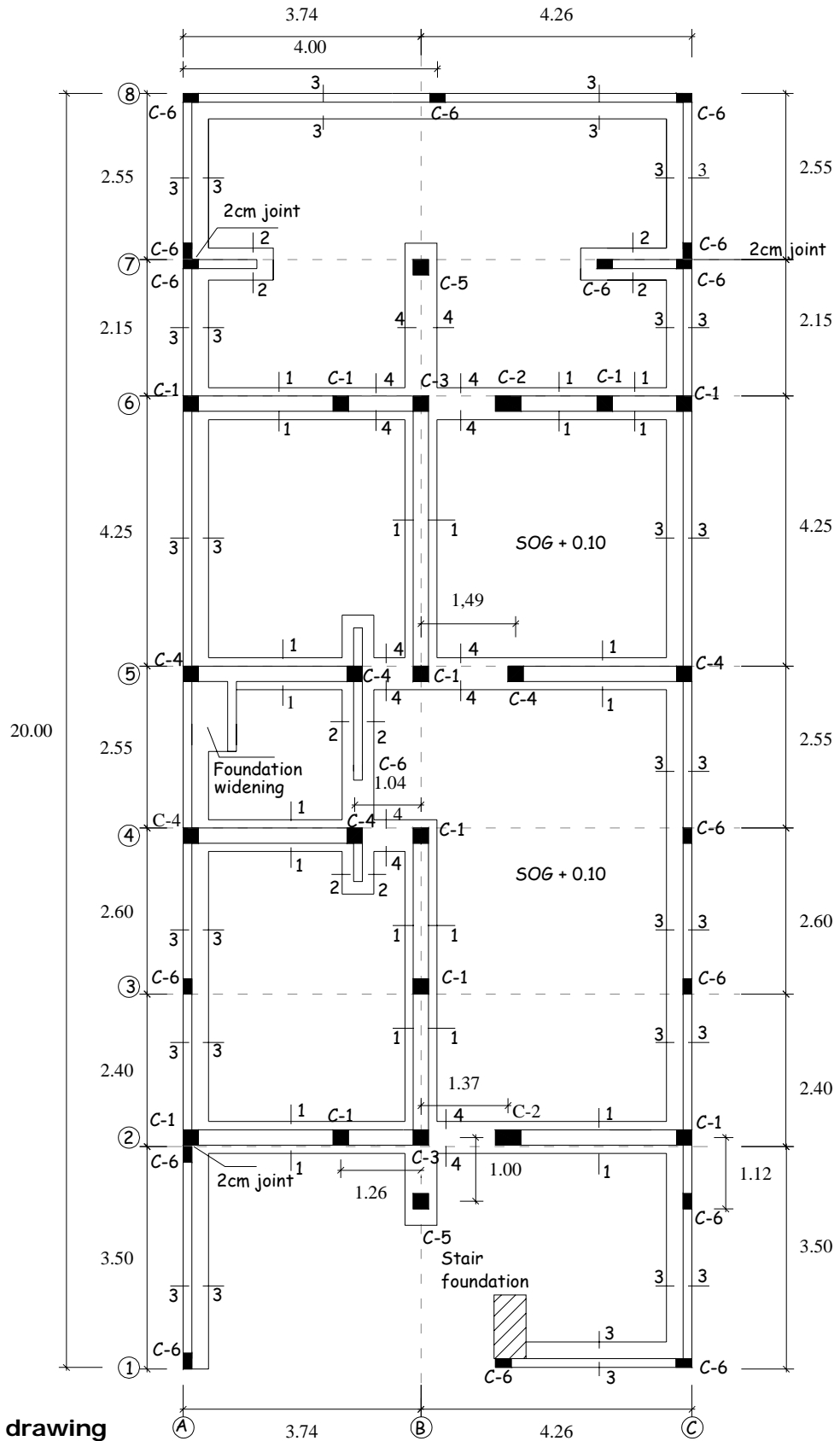

**Foundation drawing**  
Scale 1:100



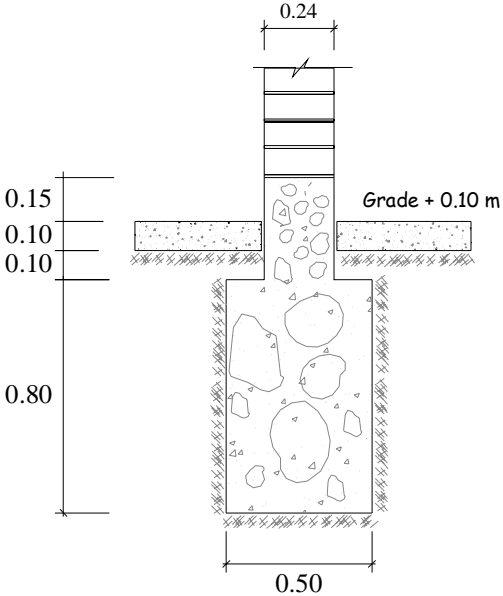

SECTION 1-1

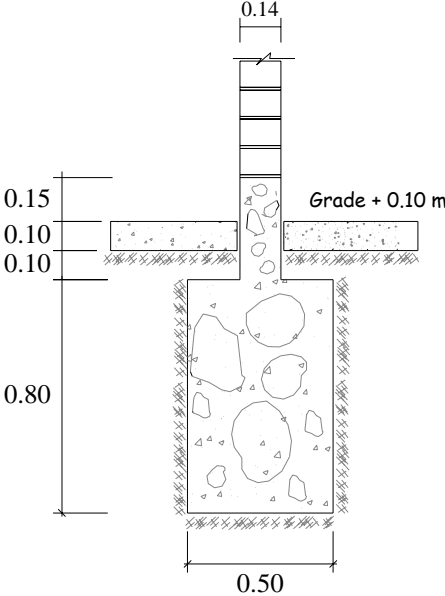

SECTION 2-2

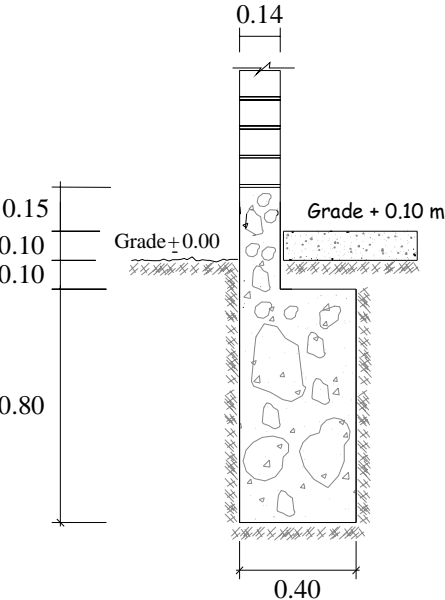



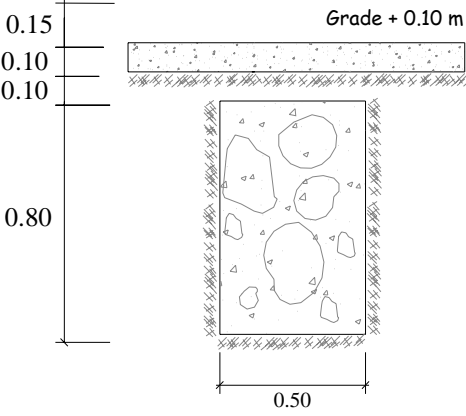

SECTION 3-3

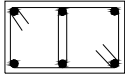

SECTION 4-4

Foundation detail drawing  
Scale 1:25

COLUMN SCHEDULE		
<p>C-1</p> <p>0.24 x 0.25</p> <p>4 <math>\phi</math> 3/8 in.</p> <p>Typical stirrups</p> 	<p>C-2</p> <p>0.24 x 0.40</p> <p>6 <math>\phi</math> 1/2 in.</p> <p>Typical stirrups</p> 	<p>C-3</p> <p>0.24 x 0.24</p> <p>4 <math>\phi</math> 3/8 in.</p> <p>Typical stirrups</p> 
<p>C-4</p> <p>0.24 x 0.25</p> <p>4 <math>\phi</math> 1/2 in.</p> <p>Typical stirrups</p> 	<p>C-5</p> <p>0.24 x 0.24</p> <p>4 <math>\phi</math> 1/2 in.</p> <p>Typical stirrups</p> 	<p>C-6</p> <p>0.14 x 0.25</p> <p>4 <math>\phi</math> 3/8 in.</p> <p>Typical stirrups</p> 
<p>Typical stirrups</p> <p><math>\square</math> <math>\phi</math> 1/4 in. 1@0.05 + 4@0.10 + R@0.25</p>		

TECHNICAL SPECIFICATIONS	
PLAIN CONCRETE:	
FOUNDATION:	
Cement, aggregate 1:10 + 30% clean large stones, maximum size 10 in.	
PLINTH:	
Cement, aggregate 1:8 + 25% clean medium size stone, maximum size 4 in.	
REINFORCED CONCRETE:	
Concrete:	
Columns, beams, slabs	$f'c = 175 \text{ kg/cm}^2$
Steel	$f_y = 4200 \text{ kg/cm}^2$
LIVE LOAD:	
First-floor roof	200 $\text{kg/m}^2$
Second-floor roof	100 $\text{kg/m}^2$
MORTAR:	
Cement : coarse sand	1:5
Joint thickness	1.00 cm
BRICK TYPE:	
Structural, good quality	
CONCRETE COVER REQUIREMENTS:	
Confining columns	2.5 cm
0.40 m columns	3.0 cm
Confining beams	2.5 cm
Flat beams and lightweight slabs	2.5 cm
Deep beams	3.0 cm

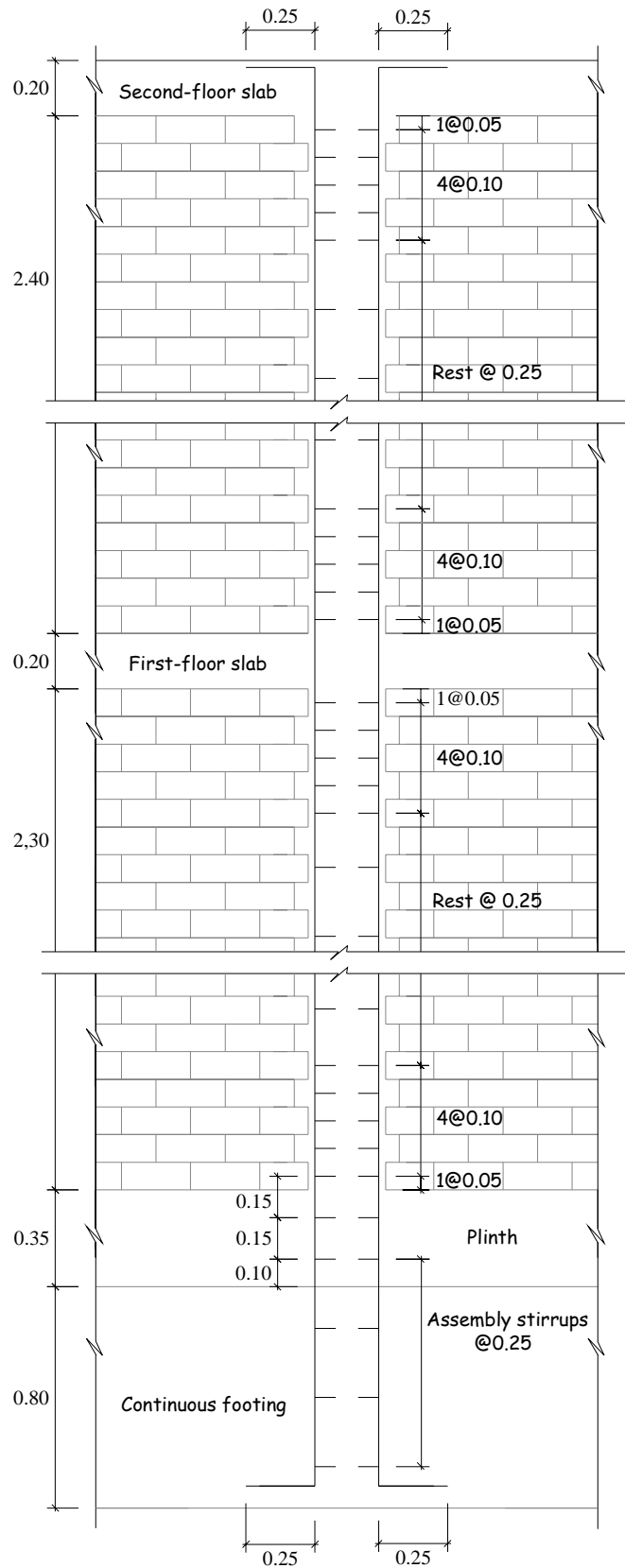

**Column detail**  
Scale 1:25

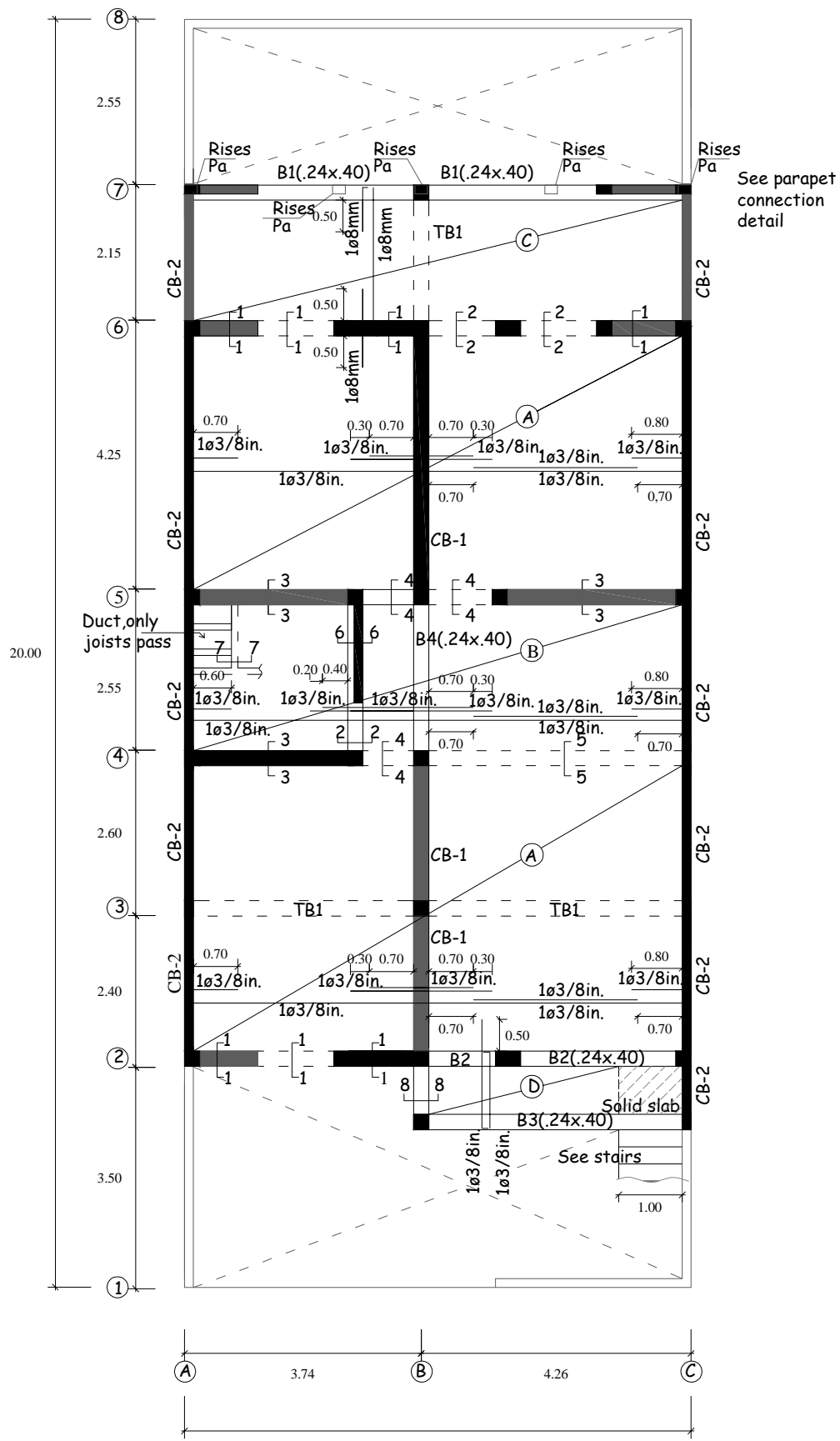

**Slab formwork drawing**  
First floor - Scale 1: 100

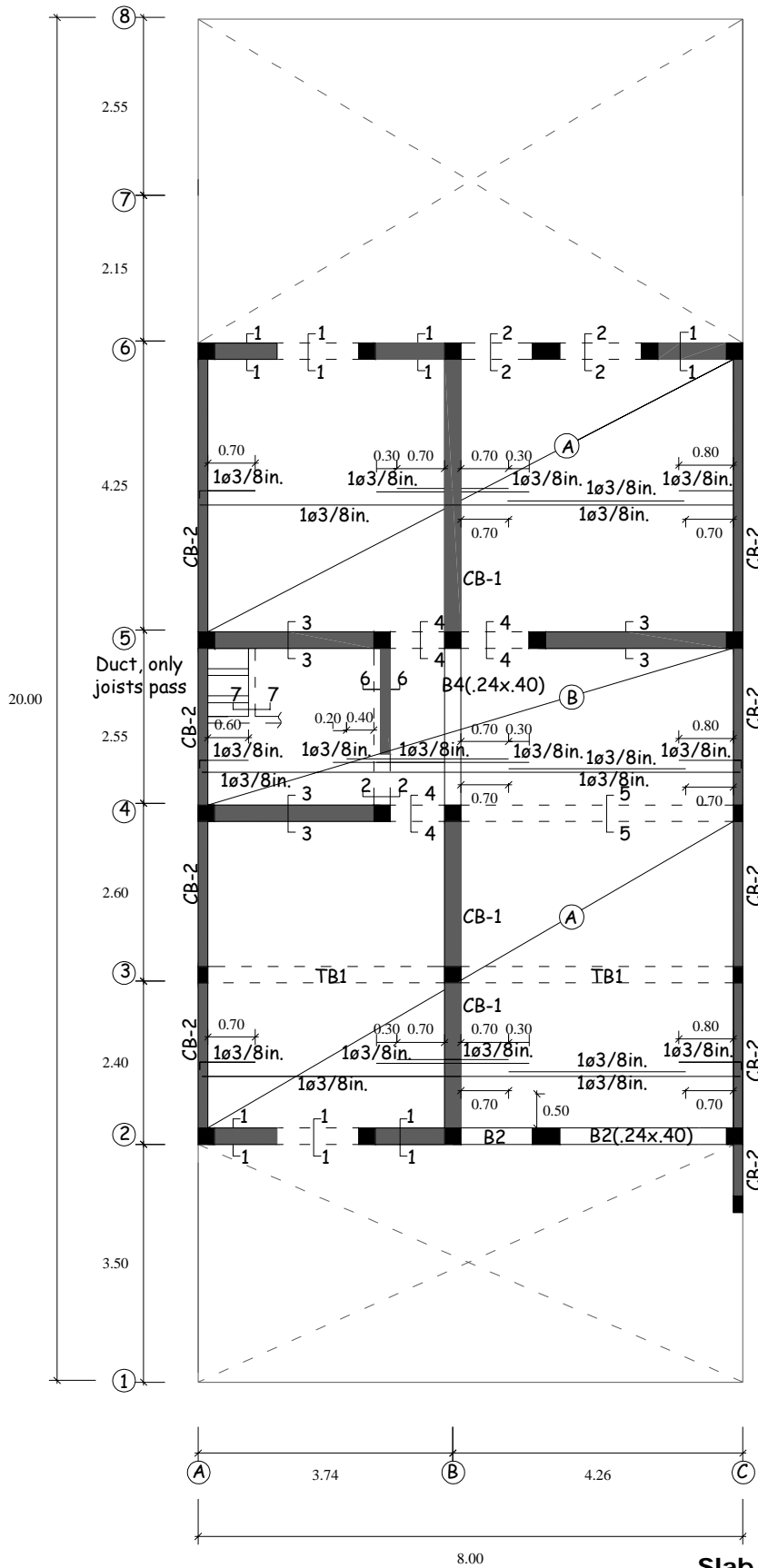

**Slab formwork drawing**  
Second floor - Scale 1:100



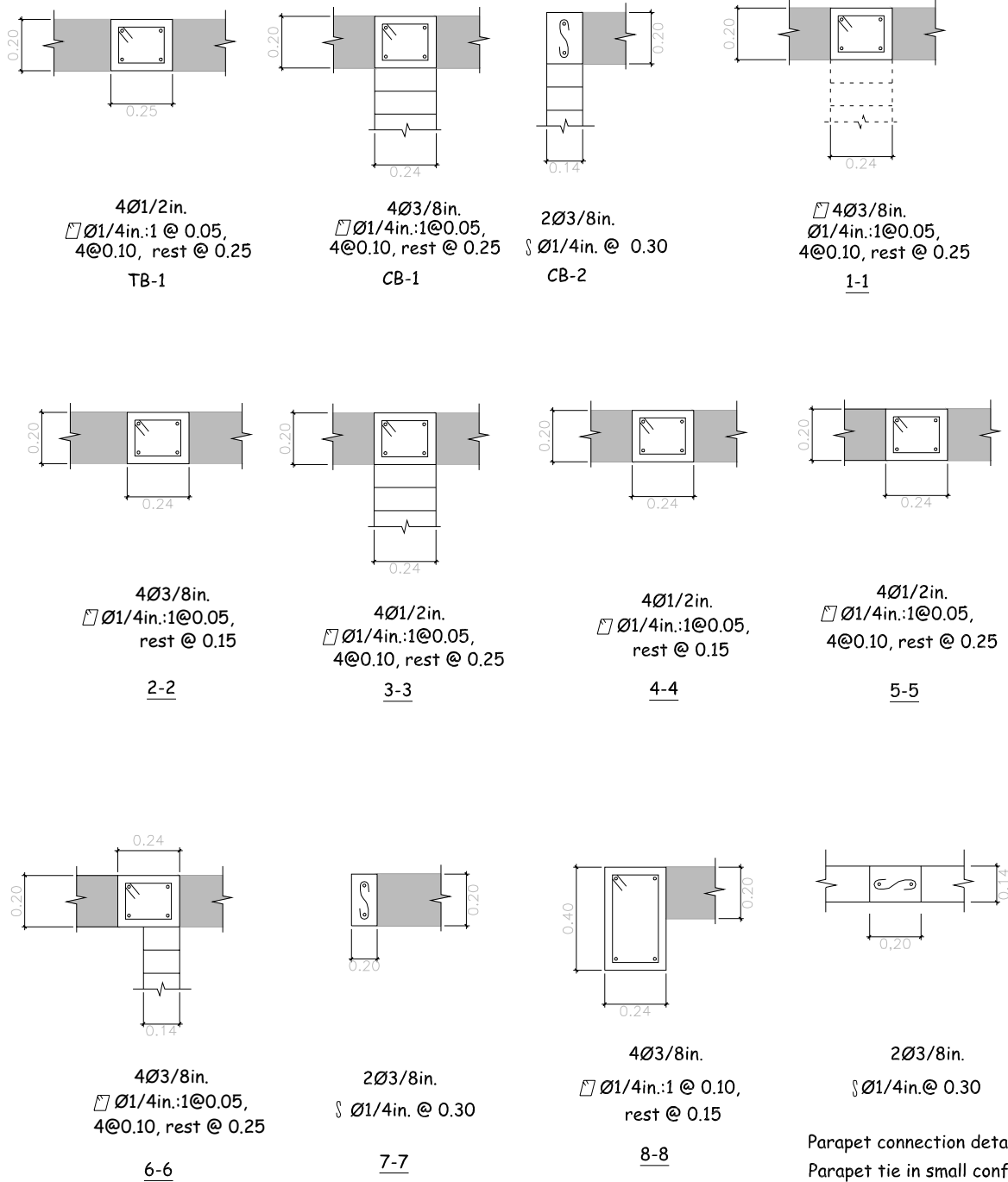

**Beam details**

Scale 1:25

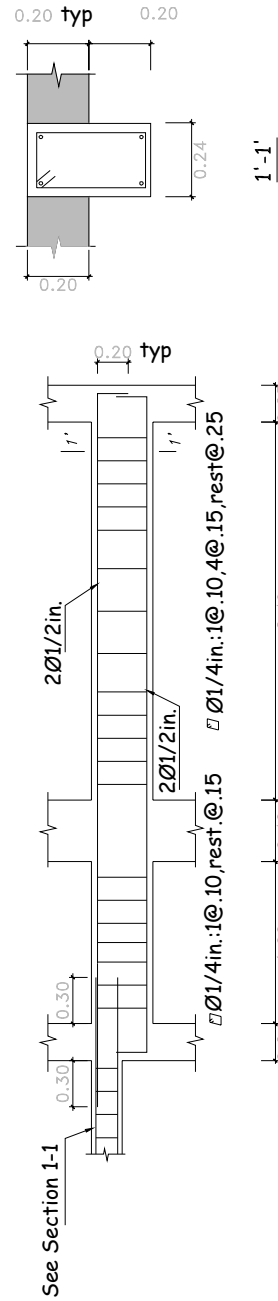
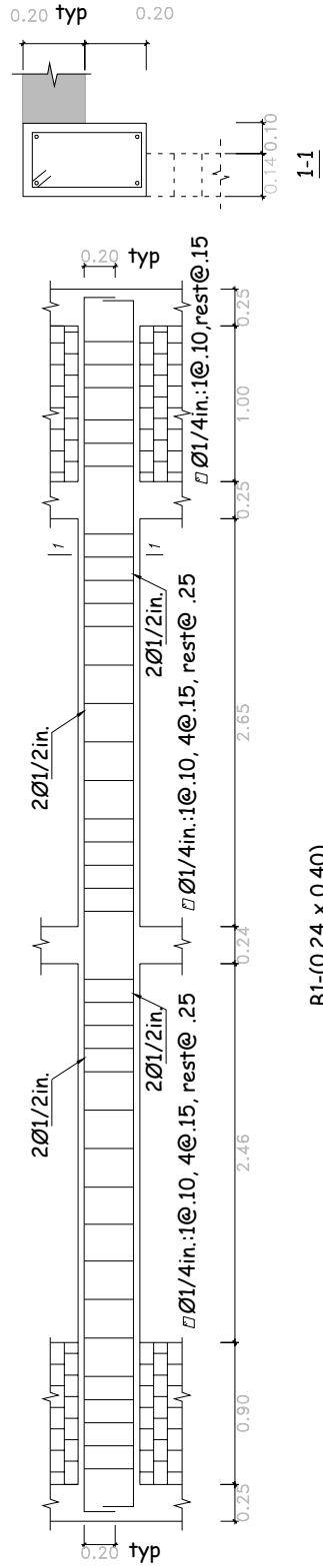

typ = typical

**Beam details**  
Scale 1:25 and 1:50

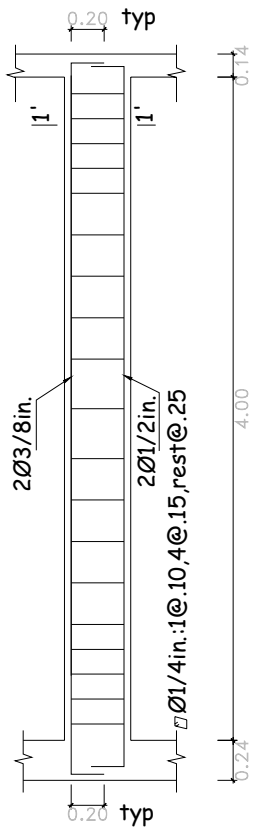
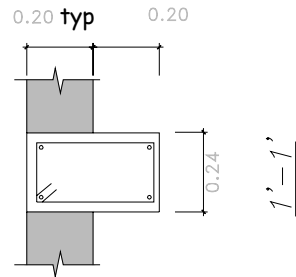
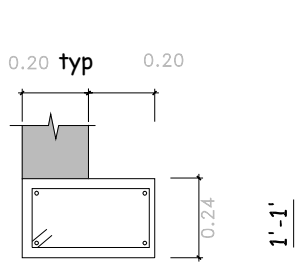

B3-(0.24 x 0.40)

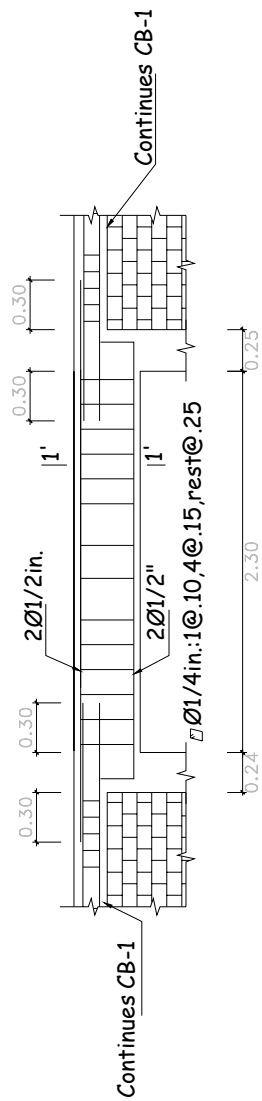

B4-(0.24 x 0.40)

typ = typical

**Beam details**

Scale 1:25 and 1:50

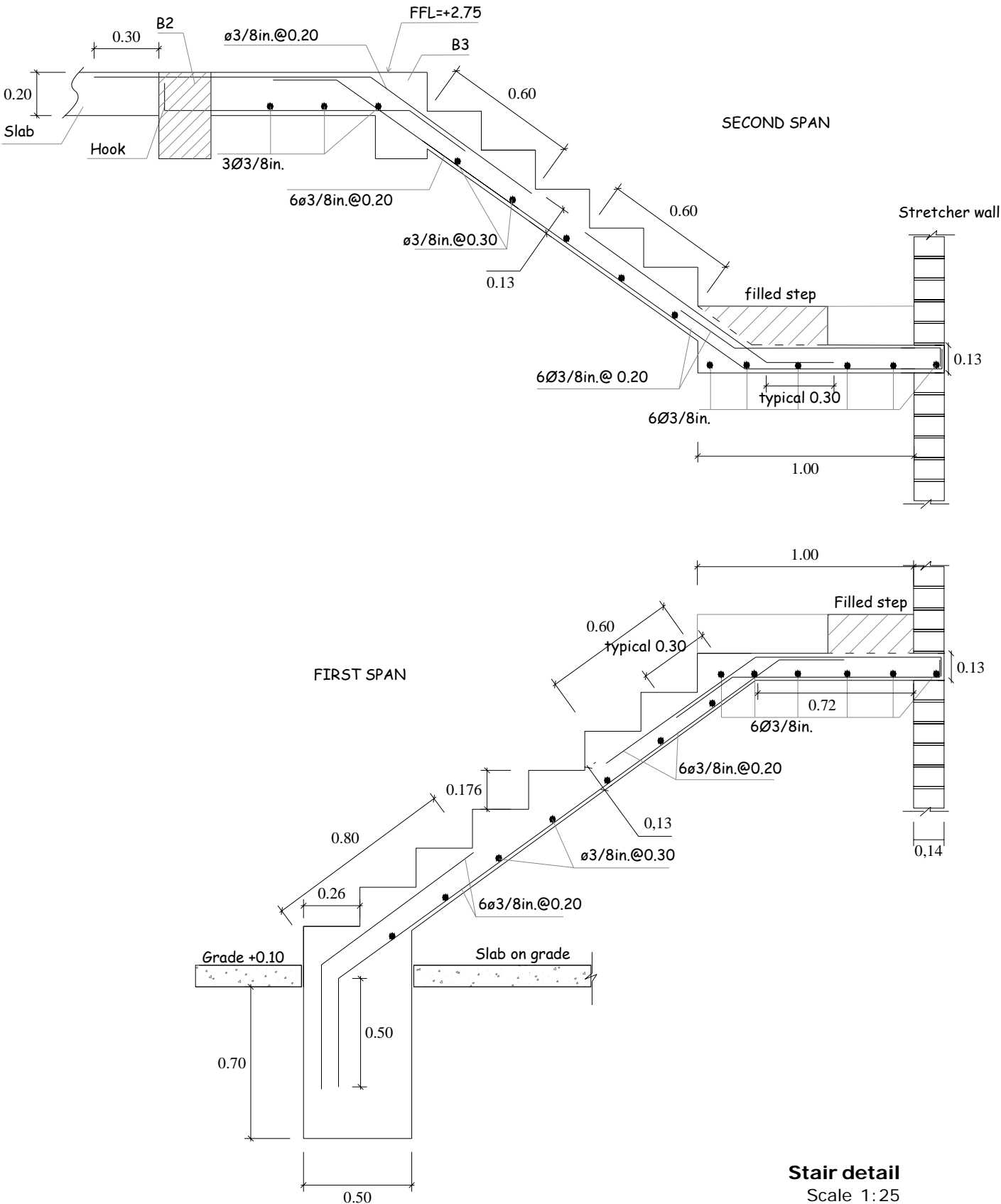

**Stair detail**  
Scale 1:25

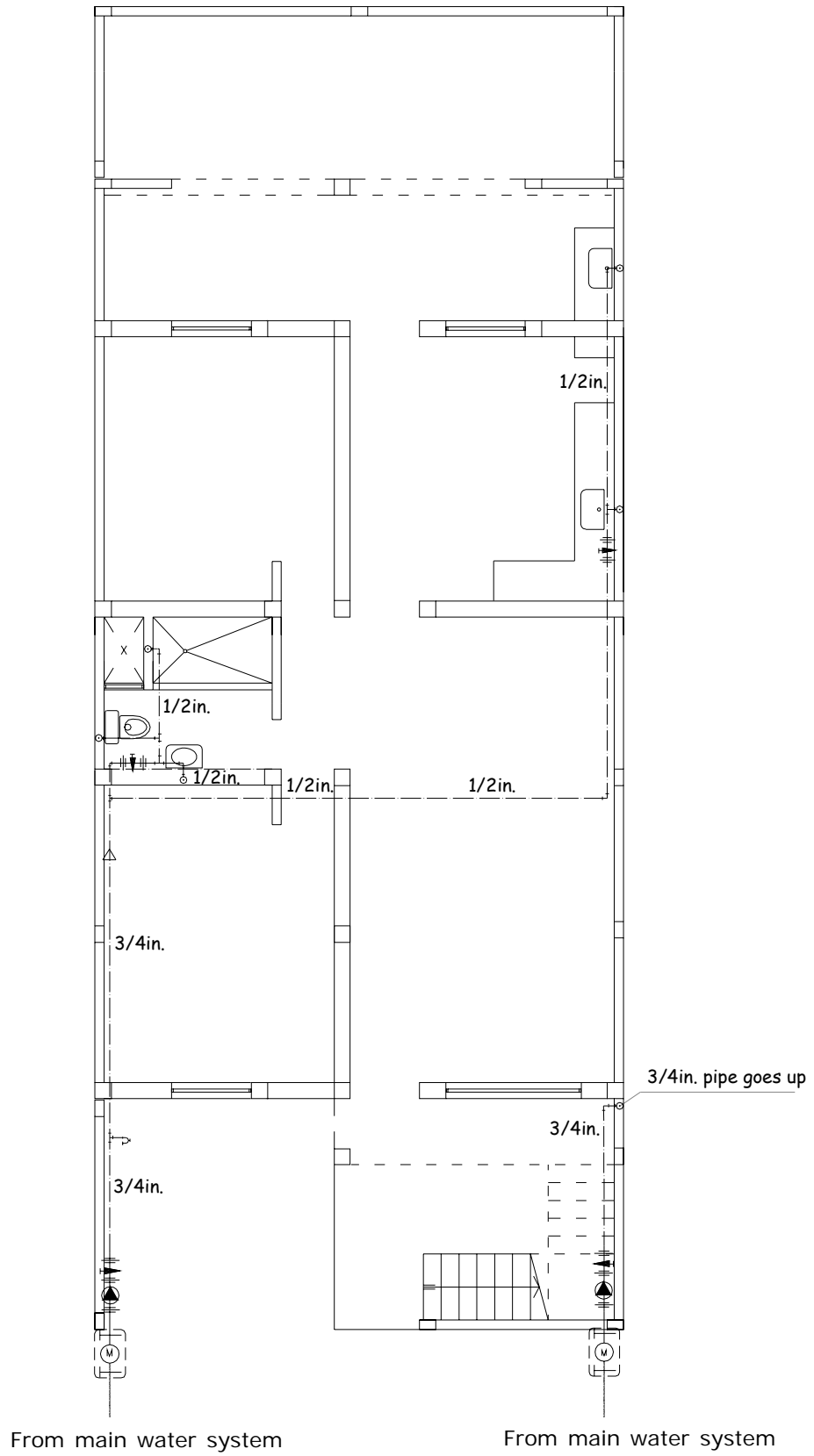

**Plumbing - water supply drawings**

First floor - Scale 1:100



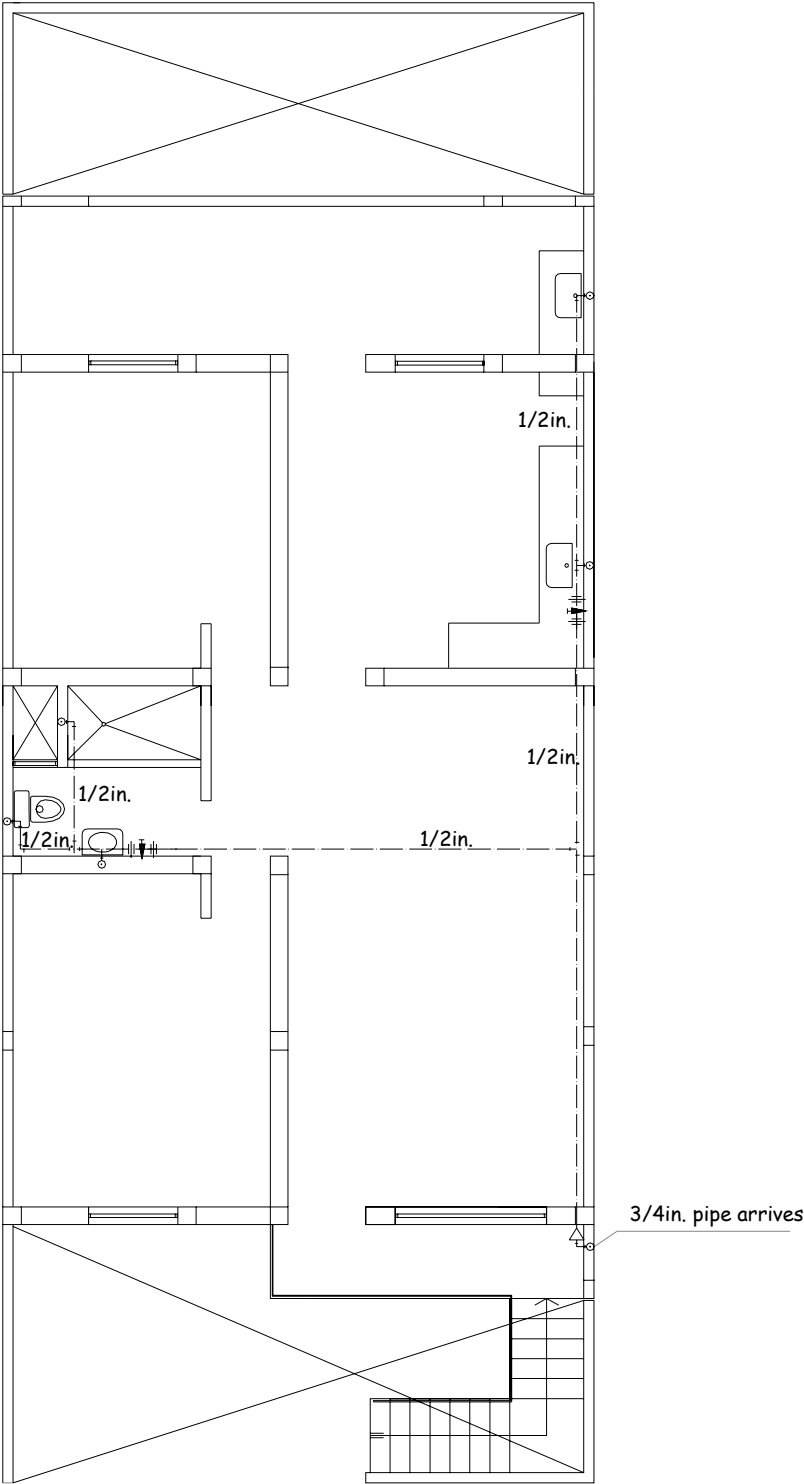

**Plumbing - water supply drawings**

Second floor - Scale 1:100

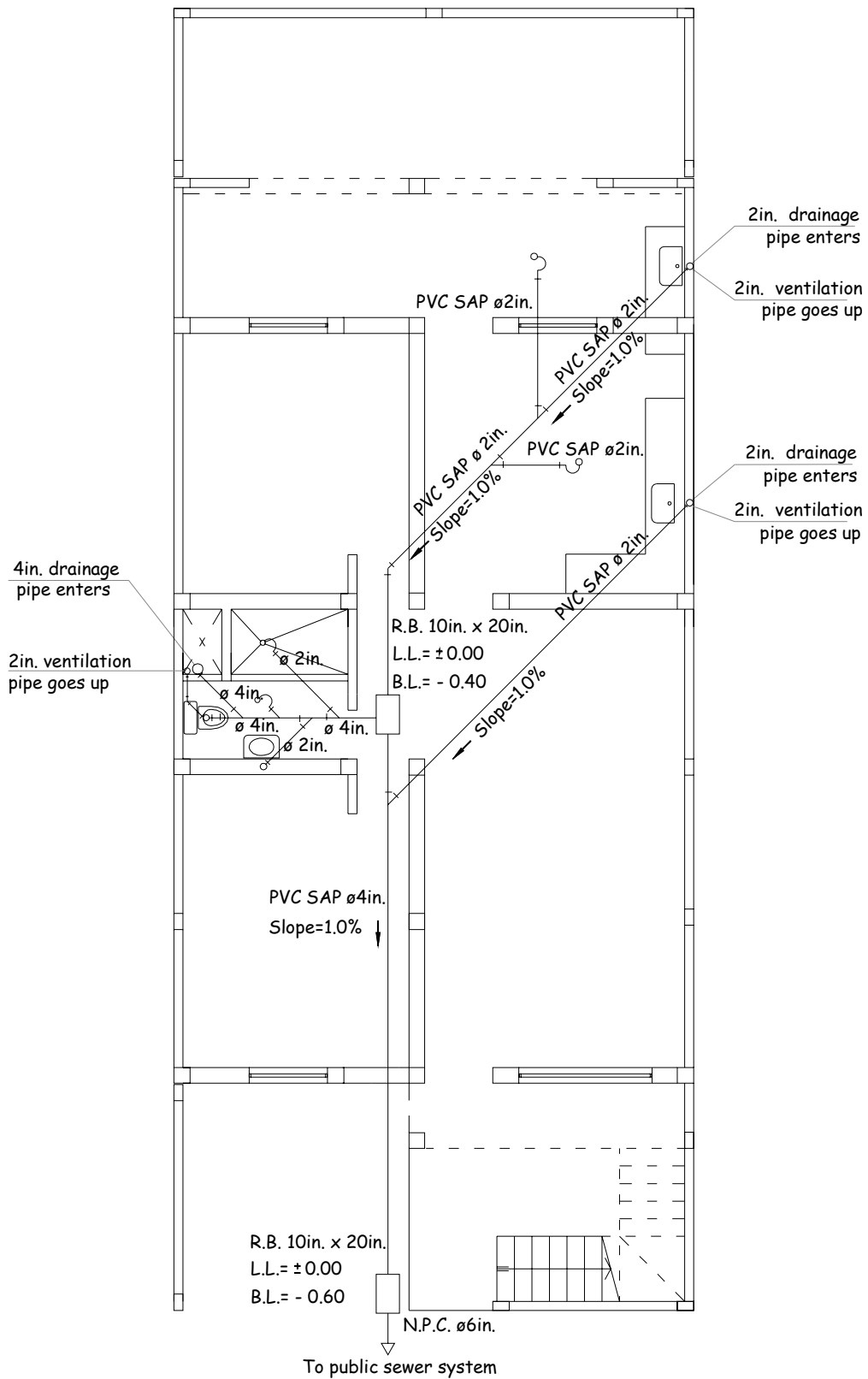

**Plumbing-sanitary sewer drawings**

First floor - Scale 1:100

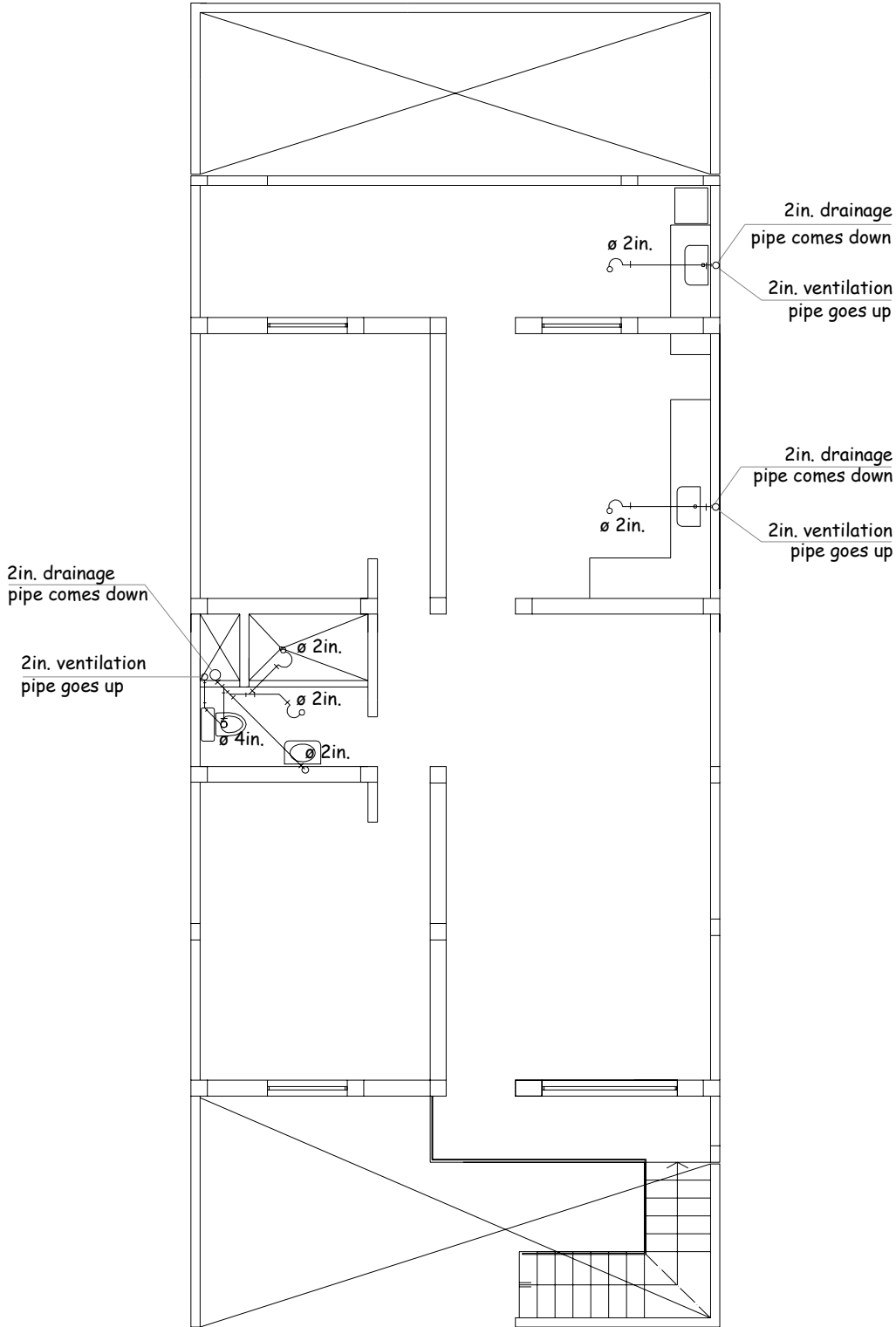

**Plumbing-sanitary sewer drawings**  
Second floor - Scale 1:100

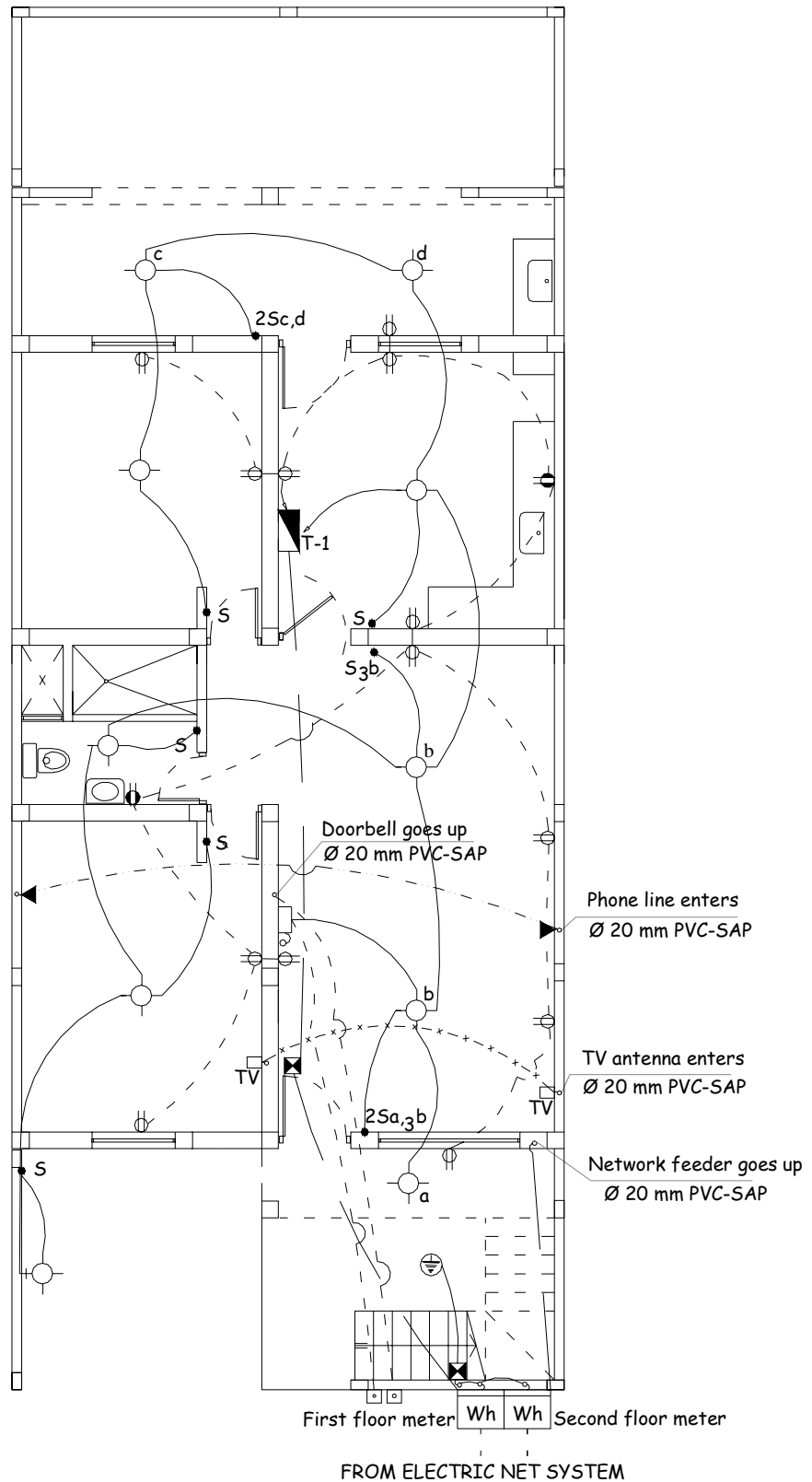

**Electrical drawings**

First floor  
Scale 1:100

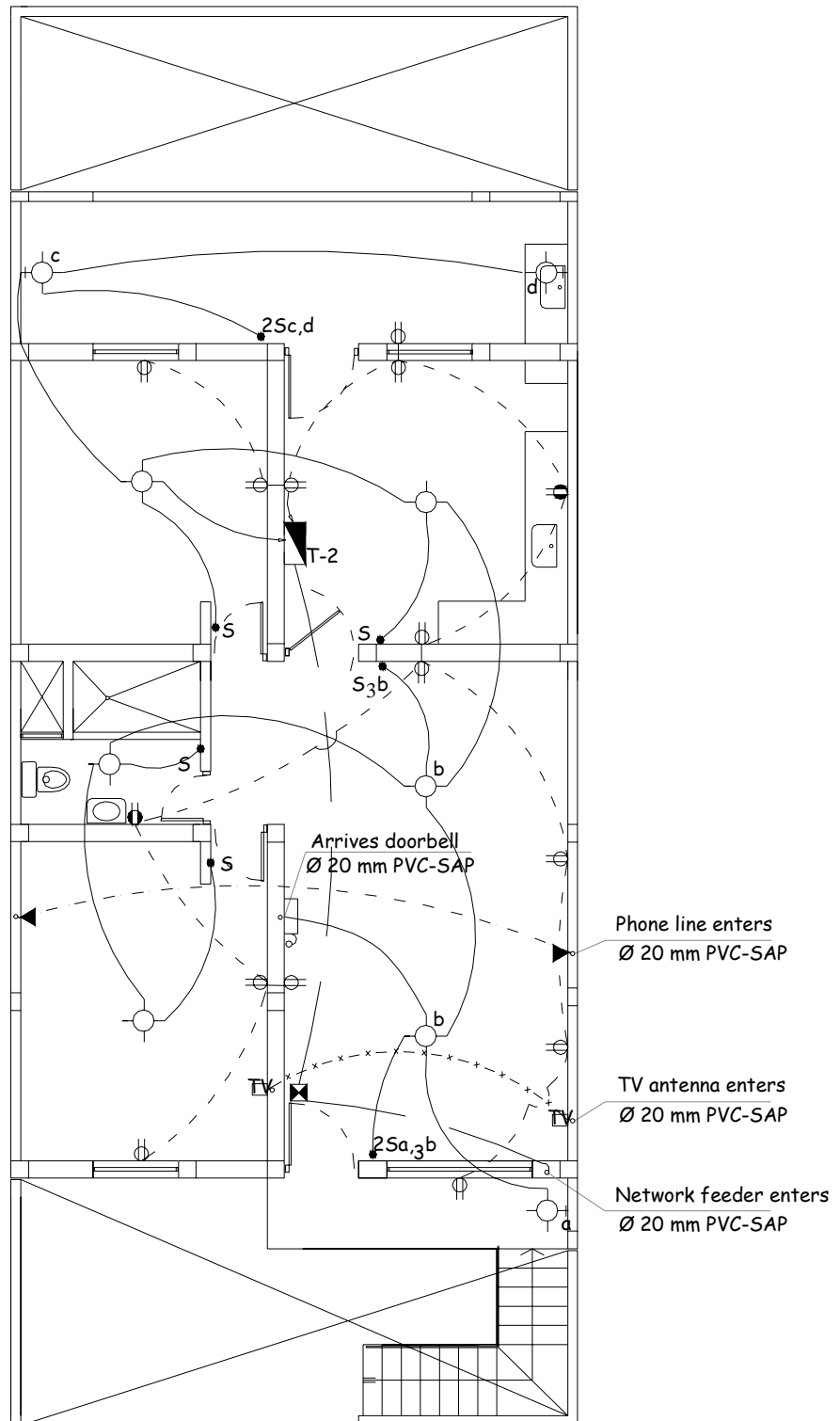

**Electrical drawings**

Second floor

Scale 1:100



### Plumbing component legend

WATER SUPPLY LEGEND		DRAINAGE LEGEND	
SYMBOL	DESCRIPTION	SYMBOL	DESCRIPTION
	WATER METER		DRAINAGE PIPE
	COLD WATER PIPE		VENTILLATION PIPE
	RIGHT ANGLE BEND		45° ELBOW
	45° ELBOW		SIMPLE SANITARY "Y"
	RIGHT ANGLE BEND GOES UP		DOUBLE SANITARY "Y"
	T		"P" TRAP
	STRAIGHT T WITH RISE		REGISTER BOX 12" x 24"
	UNIVERSAL JOINT		FLOOR BRONZE THREADED REGISTER
	GLOBE VALVE		FLOOR DRAIN
	CONCENTRIC REDUCER		
	CHECK VALVE		
	SPRINKLING VALVE		

### Electrical component legend

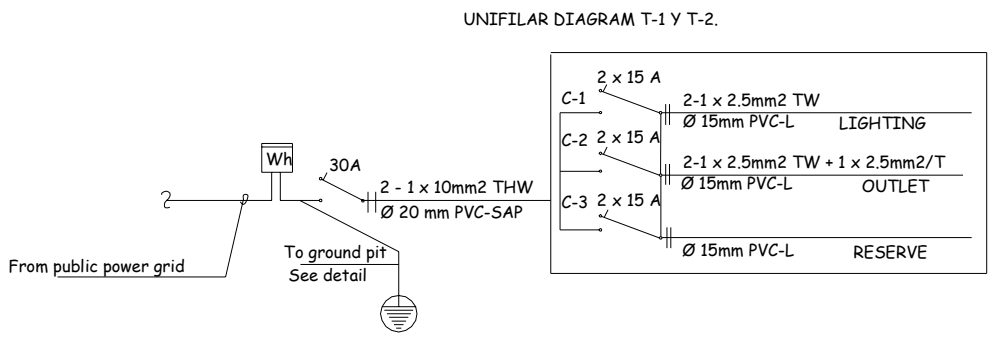

L E G E N D	
SYMBOL	DESCRIPTION
	WALL LIGHTING OUTLET
	WALL OCTOGONAL PULL BOX OF GALVANIZED IRON (G.I.) F°6° 100 x 30 h=2.20 OVER FINISHED FLOOR LEVEL
	SQUARE PULL BOX (G.I.) 100 x 30
	ROOF LIGHTING OUTLET IN OCTOGONAL BOX 100 x 30
	BIPOLAR DOUBLE OUTLET WITH UNIVERSAL TYPE CLOVIS G.I. BOX 100 x 55 x 28 h= .30/1.10 OVER FINISEHD FLOOR LEVEL RESPECTIVELY
	ELECTRIC DISTRIBUTION SWITCHBOARD, UPPER EDGE h=1.80 OVER FINISHED FLOOR LEVEL
	FOR INSTALLATION OF KHW METER
	ONE-POLE SIMPLE, DOUBLE, TRIPLE SWITCH IN G.I. BOX 100 x 53 x 28 h = 1.20 OVER FINISHED FLOOR LEVEL
	COMMUTATION SWITCH IN 100 x 43 x 28 BOX, h = 1.20 OVER FINISHED FLOOR LEVEL
	DOORBELL PUSH BUTTON IN 100 x 53 x 28 BOX, h = 1.20 OVER FINISHED FLOOR LEVEL
	EXTERNAL TELEPHONE WALL OUTLET IN 100 x 53 x 28 BOX, h = 1.20 OVER FINISHED FLOOR LEVEL
	DOORBELL IN G.I. OCTOGONAL 100 x 55 x 28 BOX, h = 1.20 OVER FINISHED FLOOR LEVEL WITH 220v 60 Hz Ø 20mm PVC-SEL TRANSFORMER
	WALL OR ROOF EMBEDDED PIPING, Ø INDICATED IN UNIFILAR DIAGRAM
	FLOOR EMBEDDED PIPING, Ø INDICATED IN UNIFILAR DIAGRAM
	FLOOR EMBEDDED PIPING, Ø 15 mm TELEPHONE
	FLOOR EMBEDDED PIPING, Ø 15 mm TV
	FLOOR EMBEDDED PIPING, Ø 15 mm DOORBELL
	TV ANTENNA OUTLET and/or CABLE, G.I. 100 x 55 x 28 BOX, h = .30 OVER FINISHED FLOOR LEVEL
	GROUND PIT

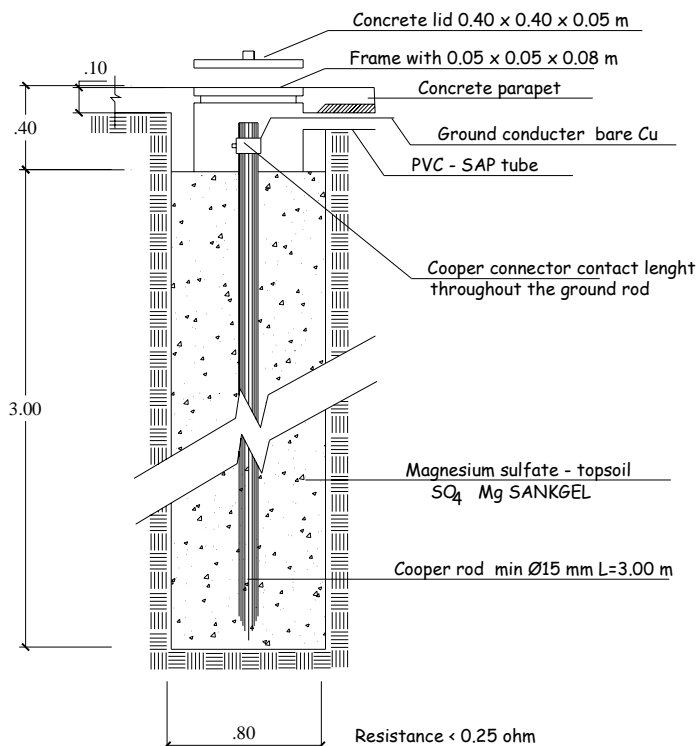

Ground pit detail

## REFERENCES

- Arnold C. y Reitherman R. 1987. **Configuración y diseño sísmico de edificios** (*Configuration and seismic design of buildings*). Editorial Limusa. México.
- Lesur L. 2001. **Manual de albañilería y autoconstrucción I y II** (*Handbook of masonry and self construction I and II*). Editorial Trillas. México.
- San Bartolomé A. 1994. **Construcciones de albañilería –Comportamiento sísmico y diseño estructural** (*Masonry constructions – Seismic behaviour and structural design*). Fondo Editorial de la PUCP. Lima, Perú.
- Servicio Nacional de Aprendizaje. 2003. **Construcción de casas sismorresistentes de uno y dos pisos** (*Construction of seismic resistant houses of one and two floors*). Universidad Nacional de Colombia. Colombia.

## 1 • Quantity of walls in an earthquake-resistant house

Your house has to have an adequate number of confined walls in both directions in order to resist earthquakes.

### Vulnerable house

Few confined walls in the direction parallel to the street.

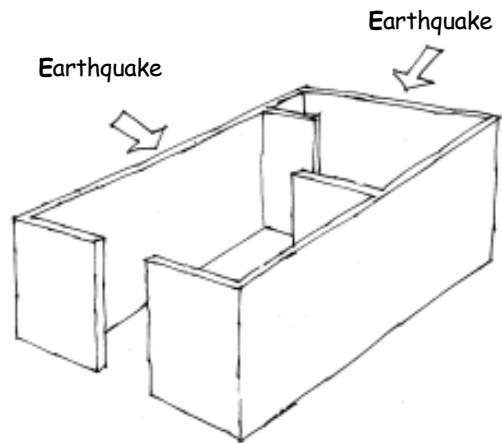

### Resistant house

Adequate quantity of confined walls in both directions

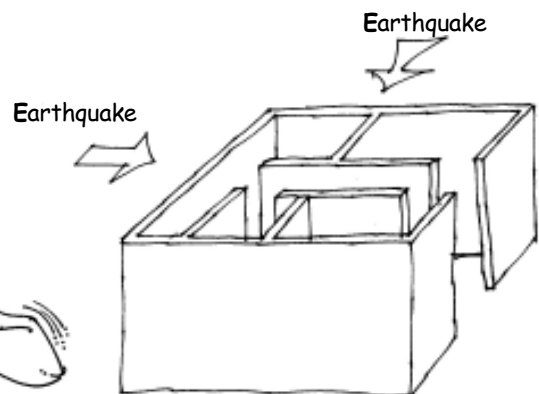

**Wall calculations**

To calculate the number of walls needed for a house with a maximum of two stories, follow the indicated steps:

**1** Classify **the soil** of the place where you will build your house. On page 22 you can learn how to determine the soil type.

**2** Determine the **minimum wall density** needed in each direction, according to your soil type. Use the following table:

Type of soil	Description	Minimum wall density required (%)
Hard	Rock Gravel	1.0%
Intermediate	Hard clayish sand	1.2%
Soft or loose	Loose sand Soft clay	1.4%



**3** Calculate the **roof area** covering each floor in square meters.

**4** Calculate the **required horizontal area of confined walls** for each floor.

$$\text{REQUIRED HORIZONTAL AREA OF CONFINED WALLS IN 1st FLOOR} = \frac{\text{MINIMUM WALL DENSITY}}{100} \times (\text{ROOF COVERED AREA 1st FLOOR} + \text{ROOF COVERED AREA 2nd FLOOR})$$

$$\text{REQUIRED HORIZONTAL AREA OF CONFINED WALLS IN 2nd FLOOR} = \frac{\text{MINIMUM WALL DENSITY}}{100} \times \text{ROOF COVERED AREA 2nd FLOOR}$$



### Example

Suppose that your house will be constructed over a compact gravel-coarse sand soil and that it will have 70 m<sup>2</sup> of roof covering area in the first floor and 50 m<sup>2</sup> in the second floor. Wall density required for hard soil is 1%.

To calculate the horizontal wall area needed in the first floor, consider the roof covering areas of the first and second floors. That is, the wall area required by the first floor will be:

#### Required horizontal area Floor 1

$$(1/100) \times (70 + 50 \text{ m}^2) = (1/100) \times 120 \text{ m}^2 = 1,20 \text{ m}^2$$

To calculate the horizontal wall area necessary in the second floor, you only have to consider the roof area covering the second floor. That is, the wall area required for the second floor will be:

#### Required horizontal area Floor 2

$$(1/100) \times (50 \text{ m}^2) = 0,5 \text{ m}^2$$



Verify that the **total horizontal area of confined walls** in your house in each **direction** is greater than the **required area**. In the evaluation only include walls made of structural brick whose length is greater than 1 meter and that are confined by reinforced concrete beams and columns. Do not include walls less than 1 meter in length. Also do not include unconfined walls or partition walls because these elements are not capable of resisting earthquakes. For each direction of your house evaluate the area of each confined wall and then add up the areas of all the walls. To calculate the horizontal area of each wall in m<sup>2</sup> multiply its length in meters by its thickness in meters.

### Example

**Horizontal wall area**  
3 m x 0,14 m = 0,42 m<sup>2</sup>

Then verify that the horizontal area of confined walls in every floor of your house and for each direction is greater than the required area that you calculated in the previous step.

Thickness  
14 cm = 0,14 m

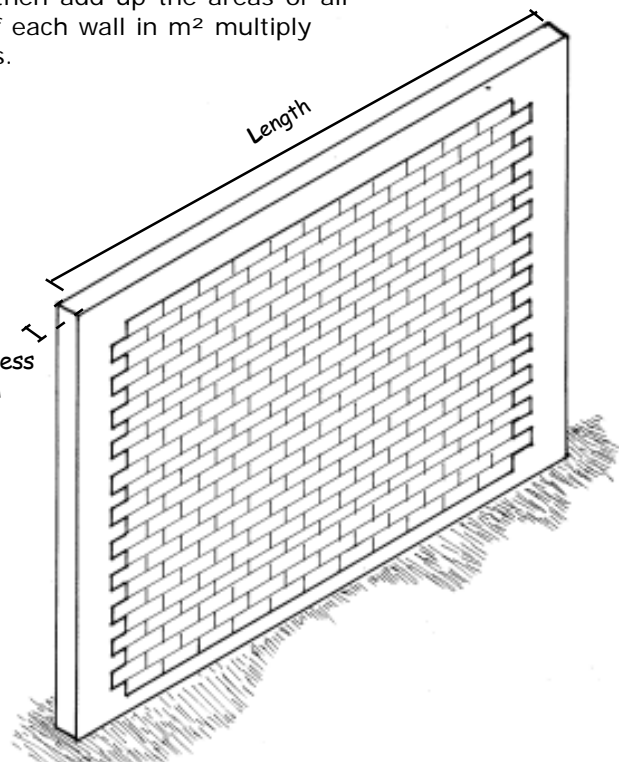

**Total horizontal wall area (m<sup>2</sup>) > Required horizontal area (m<sup>2</sup>)**

**Example of wall calculation in the direction parallel to the street**

As an example, we will analyze the house proposed in Chapter 5. This house is located over hard soil and has 115.7 m<sup>2</sup> of roof area covering in the first floor and 98.7 m<sup>2</sup> covering the second floor, which gives a total roof covering area of 214.4 m<sup>2</sup>.

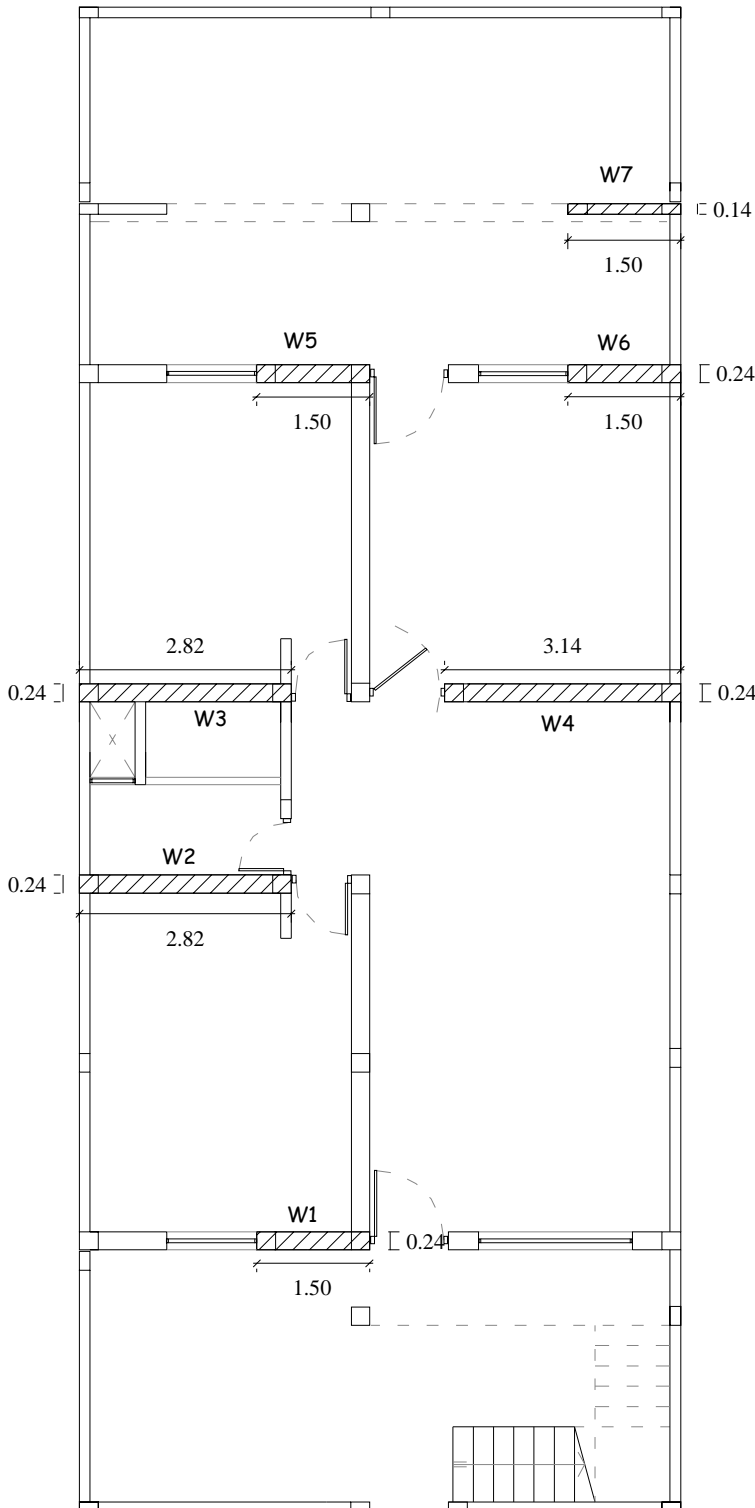

For this soil type, the required wall density in each direction is 1%. Therefore, the quantity of walls for our first floor has to be:

$$1 \times \frac{214.4 \text{ m}^2}{100} = 2.14 \text{ m}^2$$

We will calculate the areas of our confined walls:

- W1 = 1.50 X 0.24 = 0.36 m<sup>2</sup>
- W2 = 2.82 X 0.24 = 0.68 m<sup>2</sup>
- W3 = 2.82 X 0.24 = 0.68 m<sup>2</sup>
- W4 = 3.14 X 0.24 = 0.75 m<sup>2</sup>
- W5 = 1.50 X 0.24 = 0.36 m<sup>2</sup>
- W6 = 1.50 X 0.24 = 0.36 m<sup>2</sup>
- W7 = 1.50 X 0.14 = 0.24 m<sup>2</sup>

The total confined wall area is 3.43 m<sup>2</sup> which is greater than 2.14 m<sup>2</sup>, so we have satisfied minimum wall density.

Remember that these walls have to be confined in all four sides.

**Recommendation**

*It is desirable to have several walls longer than 2.70 m  
How many of the required walls must be long depends on the type of soil where your house is located:*

- ✓ **Hard soil**  
At least three walls must be longer than 2.70 m.
- ✓ **Intermediate or soft soil**  
At least four walls must be longer than 2.70 m.

## 2 • Concrete Types

**Primary plastering**  
Scratch coat

1 bucket of cement 

5 buckets of coarse sand 

Add water until the mix is workable 

**Secondary plastering**  
Finish coat

1 bucket of cement 

5 buckets of coarse sand 

Add water until the mix is workable 

**Reinforced concrete elements:**  
columns, beams, slabs, stairs

1 bucket of cement 

2 buckets of coarse sand 

4 buckets of  $\frac{3}{4}$  in. crushed stone 

1 bucket of water 

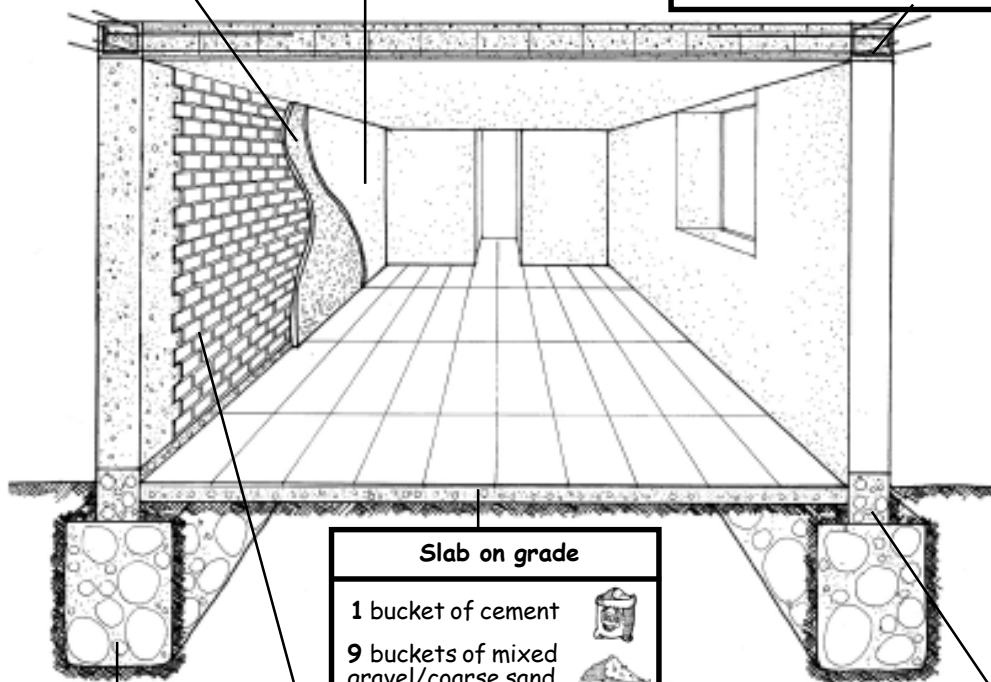

**Plain concrete for foundation**

1 bucket of cement 

10 buckets of mixed gravel/coarse sand 

30% large stones (maximum size 10in.) 

1 1/2 buckets of water 

**Mortar to lay bricks**

1 bucket of cement 

5 buckets of coarse sand 

Add water until the mix is workable 

**Slab on grade**

1 bucket of cement 

9 buckets of mixed gravel/coarse sand 

1 1/4 buckets of water 

**Plain concrete for plinth**

1 bucket of cement 

8 buckets of aggregate 

25% medium size stones (maximum size 4in.) 

1 1/4 buckets of water 

**Recommendation**

Moisten all aggregates the previous day.

### 3 • Schedule of material quantities

The quantities of materials shown includes 3% loss.

WITH THIS TABLE YOU CAN CALCULATE THE QUANTITY OF MATERIALS NECESSARY FOR CONSTRUCTION

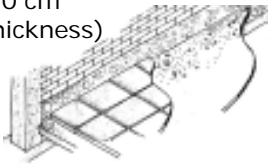
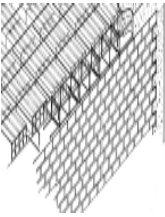
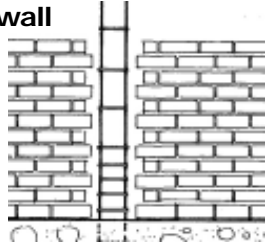
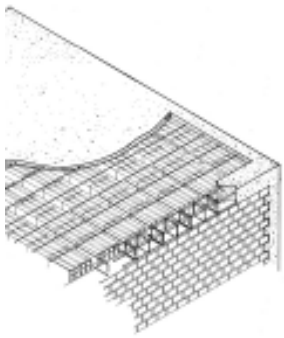

	Required material	Quantity of material for 1 m <sup>3</sup>	X	m <sup>3</sup> in my house	=	Quantity of material needed for my house
<b>Continuous footing</b> 	Cement	2.8 bags	X		=	
	Mixed gravel /coarse sand	0.90 m <sup>3</sup>				
	Big stone (10in.)	0.32 m <sup>3</sup>				
	Water	116 liters				
<b>Simple plinth</b> 	Cement	3.7 bags	X		=	
	Mixed gravel /coarse sand	1.00 m <sup>3</sup>				
	Medium size stone (4in.)	0.26 m <sup>3</sup>				
	Water	124 liters				
<b>Reinforced plinth</b> 	Cement	7.2 bags	X		=	
	Coarse sand	0.44 m <sup>3</sup>				
	Crushed stone(3/4in.)	0.9 m <sup>3</sup>				
	Water	175 liters				
<b>Columns, confining beams and slab</b> 	Cement	7,2 bags	X		=	
	Coarse sand	0.44 m <sup>3</sup>				
	Crushed stone(3/4in.)	0.9 m <sup>3</sup>				
	Water	175 liters				

	Required material	Quantity of material for 1m <sup>2</sup>	X	m <sup>2</sup> in my house	=	Quantity of material needed for my house
<b>Slab on grade</b> (10 cm thickness) 	Cement	0.4 bags	X		=	
	Mixed gravel / coarse sand	0.124 m <sup>3</sup>				
	Water	14 liters				
<b>Header wall</b> 	Cement	0.4 bags	X		=	
	Coarse sand	0.07 m <sup>3</sup>				
	Jumbo cored utility brick (10x14x24cm)	59 units				
<b>Stretcher wall</b> 	Cement	0.2 bags	X		=	
	Coarse sand	0.03 m <sup>3</sup>				
	Jumbo cored utility brick (10x14x24cm)	36 units				
	Hollow clay tile (10x12x24cm)	36 units				
<b>Lightweight slab</b> 	Cement	0.63 bags	X		=	
	Coarse sand	0.04 m <sup>3</sup>				
	Crushed stone (3/4in.)	0.008 m <sup>3</sup>				
	Water	17 liters				
	Hollow ceiling brick (15x30x30cm)	8.4 units				
	Hollow ceiling brick (15x30x25cm)	10.5 units				
	Hollow ceiling brick (12x30x25cm)	10.5 units				

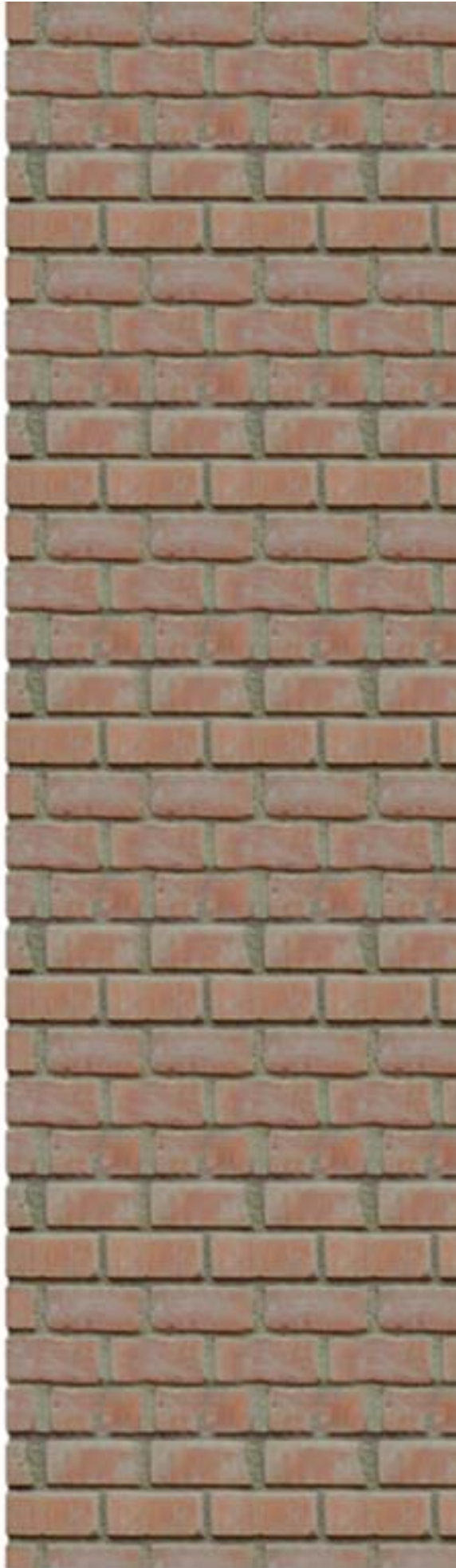

**Gobierno  
del Perú**

Trabajo de parientes



**Ministerio  
de Vivienda,  
Construcción  
y Saneamiento**